

**BL 3.50/02/90F SN OR BX**
**Weidmüller Interface GmbH & Co. KG**

Klingenbergstraße 26

D-32758 Detmold

Germany

www.weidmueller.com

**Product image**

Female connectors with clamping yoke screw system for connecting conductors at 3.50 mm pitch. They provide space for labelling and can be coded.

**General ordering data**

Version	PCB plug-in connector, female plug, 3.50 mm, Number of poles: 2, 90°, Clamping yoke connection, Clamping range, max.: 1.5 mm <sup>2</sup> , Box
Order No.	<a href="#">1639010000</a>
Type	BL 3.50/02/90F SN OR BX
GTIN (EAN)	4008190276553
Qty.	132 pc(s).
Product data	IEC: 320 V / 12 A / 0.2 - 1.5 mm <sup>2</sup> UL: 300 V / 8 A / AWG 28 - AWG 14
Packaging	Box

Creation date September 4, 2023 12:52:30 PM CEST

## BL 3.50/02/90F SN OR BX

Weidmüller Interface GmbH &amp; Co. KG

Klingenbergstraße 26

D-32758 Detmold

Germany

www.weidmueller.com

## Technical data

## Dimensions and weights

Depth	22.45 mm	Depth (inches)	0.884 inch
Height	12 mm	Height (inches)	0.472 inch
Width	14 mm	Width (inches)	0.551 inch
Net weight	2.36 g		

## Temperatures

Operating temperature, min.	-50 °C	Operating temperature, max.	100 °C
-----------------------------	--------	-----------------------------	--------

## System Parameters

Product family	OMNIMATE Signal - series BL/SL 3.50		
Type of connection	Field connection		
Wire connection method	Clamping yoke connection		
Pitch in mm (P)	3.5 mm		
Pitch in inches (P)	0.138 inch		
Conductor outlet direction	90°		
Number of poles	2		
L1 in mm	3.5 mm		
L1 in inches	0.138 inch		
Number of rows	1		
Pin series quantity	1		
Rated cross-section	1.5 mm <sup>2</sup>		
Touch-safe protection acc. to DIN VDE 57 106	Safe from finger touch		
Touch-safe protection acc. to DIN VDE 0470	IP20 plugged/ IP10 unplugged		
Protection degree	IP20, when fully mounted		
Volume resistance	≤5 mΩ		
Can be coded	Yes		
Stripping length	6 mm		
Clamping screw	M 2		
Screwdriver blade	0.4 x 2.5		
Screwdriver blade standard	DIN 5264		
Plugging cycles	25		
Plugging force/pole, max.	7 N		
Pulling force/pole, max.	5 N		
Tightening torque	Torque type	Wire connection	
	Usage information	Tightening torque	min. 0.2 Nm
			max. 0.25 Nm
	Torque type	Screw flange	
Usage information	Tightening torque	min. 0.15 Nm	
		max. 0.2 Nm	

## Material data

Insulating material	PBT	Colour	orange
Colour chart (similar)	RAL 2000	Insulating material group	IIIa
Comparative Tracking Index (CTI)	≥ 200	Insulation strength	≥ 10 <sup>8</sup> Ω
UL 94 flammability rating	V-0	Contact material	Copper alloy
Contact surface	tinned	Layer structure of plug contact	4...8 μm Sn hot-dip tinned
Storage temperature, min.	-40 °C	Storage temperature, max.	70 °C
Operating temperature, min.	-50 °C	Operating temperature, max.	100 °C
Temperature range, installation, min.	-30 °C	Temperature range, installation, max.	100 °C

Creation date September 4, 2023 12:52:30 PM CEST

Catalogue status 18.08.2023 / We reserve the right to make technical changes.

2

## BL 3.50/02/90F SN OR BX

**Weidmüller Interface GmbH & Co. KG**  
 Klingenbergstraße 26  
 D-32758 Detmold  
 Germany

www.weidmueller.com

## Technical data

### Conductors suitable for connection

Clamping range, min.	0.08 mm <sup>2</sup>
Clamping range, max.	1.5 mm <sup>2</sup>
Wire connection cross section AWG, min.	AWG 28
Wire connection cross section AWG, max.	AWG 14
Solid, min. H05(07) V-U	0.2 mm <sup>2</sup>
Solid, max. H05(07) V-U	1.5 mm <sup>2</sup>
Flexible, min. H05(07) V-K	0.2 mm <sup>2</sup>
Flexible, max. H05(07) V-K	1.5 mm <sup>2</sup>
w. plastic collar ferrule, DIN 46228 pt 4, 0.2 mm <sup>2</sup> min.	
w. plastic collar ferrule, DIN 46228 pt 4, 1.5 mm <sup>2</sup> max.	
w. wire end ferrule, DIN 46228 pt 1, min.	0.2 mm <sup>2</sup>
w. wire end ferrule, DIN 46228 pt 1, max.	1.5 mm <sup>2</sup>
Plug gauge in accordance with EN 60999 a x b; ø	2.4 mm x 1.5 mm

Clampable conductor	Cross-section for conductor connection	Type	fine-wired
		nominal	0.5 mm <sup>2</sup>
wire end ferrule	wire end ferrule	Stripping length	nominal 8 mm
		Recommended wire-end ferrule	<a href="#">H0.5/12 OR</a>
		Stripping length	nominal 6 mm
		Recommended wire-end ferrule	<a href="#">H0.5/6</a>
Cross-section for conductor connection	wire end ferrule	Type	fine-wired
		nominal	0.75 mm <sup>2</sup>
		Stripping length	nominal 8 mm
		Recommended wire-end ferrule	<a href="#">H0.75/12 W</a>
Cross-section for conductor connection	wire end ferrule	Stripping length	nominal 6 mm
		Recommended wire-end ferrule	<a href="#">H0.75/6</a>
		Type	fine-wired
		nominal	1 mm <sup>2</sup>
Cross-section for conductor connection	wire end ferrule	Stripping length	nominal 8 mm
		Recommended wire-end ferrule	<a href="#">H1.0/12 GE</a>
		Stripping length	nominal 6 mm
		Recommended wire-end ferrule	<a href="#">H1.0/6</a>
Cross-section for conductor connection	wire end ferrule	Type	fine-wired
		nominal	0.25 mm <sup>2</sup>
		Stripping length	nominal 8 mm
		Recommended wire-end ferrule	<a href="#">H0.25/10 HBL</a>
Cross-section for conductor connection	wire end ferrule	Stripping length	nominal 5 mm
		Recommended wire-end ferrule	<a href="#">H0.25/5</a>
		Type	fine-wired
		nominal	0.34 mm <sup>2</sup>
Cross-section for conductor connection	wire end ferrule	Stripping length	nominal 8 mm
		Recommended wire-end ferrule	<a href="#">H0.34/10 TK</a>

## BL 3.50/02/90F SN OR BX

Weidmüller Interface GmbH &amp; Co. KG

Klingenbergstraße 26

D-32758 Detmold

Germany

www.weidmueller.com

## Technical data

Reference text The outside diameter of the plastic collar should not be larger than the pitch (P), Length of ferrules is to be chosen depending on the product and the rated voltage.

## Rated data acc. to IEC

tested acc. to standard	IEC 60664-1, IEC 61984	Rated current, min. number of poles (Tu=20°C)	12 A
Rated current, max. number of poles (Tu=20°C)	10 A	Rated current, min. number of poles (Tu=40°C)	10 A
Rated current, max. number of poles (Tu=40°C)	8 A	Rated voltage for surge voltage class / pollution degree II/2	320 V
Rated voltage for surge voltage class / pollution degree III/2	160 V	Rated voltage for surge voltage class / pollution degree III/3	160 V
Rated impulse voltage for surge voltage class/ pollution degree II/2	2.5 kV	Rated impulse voltage for surge voltage class/ pollution degree III/2	2.5 kV
Rated impulse voltage for surge voltage class/ contamination degree III/3	2.5 kV	Short-time withstand current resistance	3 x 1s with 100 A

## Rated data acc. to CSA

Institute (CSA)		Certificate No. (CSA)	154685-1318353
Rated voltage (Use group B / CSA)	300 V	Rated voltage (Use group D / CSA)	300 V
Rated current (Use group B / CSA)	10 A	Rated current (Use group D / CSA)	10 A
Wire cross-section, AWG, min.	AWG 28	Wire cross-section, AWG, max.	AWG 14
Reference to approval values	Specifications are maximum values, details - see approval certificate.		

## Rated data acc. to UL 1059

Institute (UR)		Certificate No. (UR)	E60693
Rated voltage (Use group B / UL 1059)	300 V	Rated voltage (Use group D / UL 1059)	300 V
Rated current (Use group B / UL 1059)	8 A	Rated current (Use group D / UL 1059)	8 A
Wire cross-section, AWG, min.	AWG 28	Wire cross-section, AWG, max.	AWG 14
Reference to approval values	Specifications are maximum values, details - see approval certificate.		

## Packing

Packaging	Box	VPE length	348 mm
VPE width	135 mm	VPE height	31 mm

## Type tests

Test: Durability of markings	Standard	DIN EN 61984 section 7.3.2 / 09.02 taking pattern from DIN EN 60068-2-70 / 07.96
	Test	mark of origin, type identification, approval marking SEV, approval marking CSA
	Evaluation	available
	Test	durability
	Evaluation	passed

Creation date September 4, 2023 12:52:30 PM CEST

Catalogue status 18.08.2023 / We reserve the right to make technical changes.

4

## BL 3.50/02/90F SN OR BX

**Weidmüller Interface GmbH & Co. KG**  
 Klingenbergstraße 26  
 D-32758 Detmold  
 Germany

www.weidmueller.com

## Technical data

Test: Misengagement (Non-interchangeability)	Standard	DIN EN 61984 section 6.3 and 6.9.1 / 09.02, DIN IEC 60512 part 7 section 5 / 05.94		
	Test	180° turned with coding elements		
	Evaluation	passed		
Test: Clampable cross section	Standard	DIN EN 60999-1 section 7 and 9.1 / 12.00, DIN EN 60947-1 section 8.2.4.5.1 / 12.99		
	Conductor type	Type of conductor and conductor cross-section	solid 0.2 mm <sup>2</sup>	
		Type of conductor and conductor cross-section	stranded 0.2 mm <sup>2</sup>	
		Type of conductor and conductor cross-section	solid 1.5 mm <sup>2</sup>	
		Type of conductor and conductor cross-section	stranded 1.5 mm <sup>2</sup>	
		Type of conductor and conductor cross-section	AWG 28/1	
		Type of conductor and conductor cross-section	AWG 28/19	
		Type of conductor and conductor cross-section	AWG 16/1	
		Type of conductor and conductor cross-section	AWG 16/19	
	Evaluation	passed		
Test for damage to and accidental loosening of conductors	Standard	DIN EN 60999-1 section 9.4 / 12.00		
	Requirement	0.2 kg		
	Conductor type	Type of conductor and conductor cross-section	AWG 28/1	
		Type of conductor and conductor cross-section	AWG 28/19	
	Evaluation	passed		
	Requirement	0.3 kg		
	Conductor type	Type of conductor and conductor cross-section	2 × AWG 24/1	
		Type of conductor and conductor cross-section	2 × AWG 24/19 with wire end ferrule	
	Evaluation	passed		
	Requirement	0.4 kg		
Conductor type	Type of conductor and conductor cross-section	solid 1.5 mm <sup>2</sup>		
	Type of conductor and conductor cross-section	stranded 1.5 mm <sup>2</sup>		
	Type of conductor and conductor cross-section	AWG 16/7		
Evaluation	passed			

## BL 3.50/02/90F SN OR BX

Weidmüller Interface GmbH &amp; Co. KG

Klingenbergstraße 26

D-32758 Detmold

Germany

www.weidmueller.com

## Technical data

Pull-out test	Standard	DIN EN 60999-1 section 9.5 / 12.00		
	Requirement	≥5 N		
	Conductor type	Type of conductor and conductor cross-section	AWG 28/1	
		Type of conductor and conductor cross-section	AWG 28/19	
	Evaluation	passed		
	Requirement	≥10 N		
	Conductor type	Type of conductor and conductor cross-section	2 × AWG 24/1	
		Type of conductor and conductor cross-section	2 × AWG 24/19 with wire end ferrule	
	Evaluation	passed		
	Requirement	≥40 N		
	Conductor type	Type of conductor and conductor cross-section	H05V-U1.5	
		Type of conductor and conductor cross-section	H05V-K1.5	
Type of conductor and conductor cross-section		AWG 16/7		
Evaluation	passed			

## Classifications

ETIM 6.0	EC002638	ETIM 7.0	EC002638
ETIM 8.0	EC002638	ECLASS 9.0	27-44-03-09
ECLASS 9.1	27-44-03-09	ECLASS 10.0	27-44-03-09
ECLASS 11.0	27-46-02-02	ECLASS 12.0	27-46-02-02

## Important note

IPC conformity Conformity: The products are developed, manufactured and delivered according international recognized standards and norms and comply with the assured properties in the data sheet resp. fulfill decorative properties in accordance with IPC-A-610 "Class 2". Further claims on the products can be evaluated on request.

- Notes
- Additional variants on request
  - Gold-plated contact surfaces on request
  - Rated current related to rated cross-section & min. No. of poles.
  - Max. outer diameter of the conductor: 2.9 mm
  - Wire end ferrule without plastic collar to DIN 46228/1
  - Wire end ferrule with plastic collar to DIN 46228/4
  - P on drawing = pitch
  - Rated data refer only to the component itself. Clearance and creepage distances to other components are to be designed in accordance with the relevant application standards.
  - Long term storage of the product with average temperature of 50 °C and average humidity 70%, 36 months

Creation date September 4, 2023 12:52:30 PM CEST

Catalogue status 18.08.2023 / We reserve the right to make technical changes.

**Data sheet**

**BL 3.50/02/90F SN OR BX**

**Weidmüller Interface GmbH & Co. KG**  
 Klingenbergstraße 26  
 D-32758 Detmold  
 Germany

www.weidmueller.com

**Technical data**

**Approvals**

Approvals



ROHS	Conform
UL File Number Search	UL Website
Certificate No. (UR)	E60693

**Downloads**

Approval/Certificate/Document of Conformity	<a href="#">Declaration of the Manufacturer</a>
Engineering Data	<a href="#">CAD data – STEP</a>
Catalogues	<a href="#">Catalogues in PDF-format</a>
Brochures	<a href="#">FL DRIVES EN</a> <a href="#">MB DEVICE MANUF. EN</a> <a href="#">FL DRIVES DE</a> <a href="#">FL BUILDING SAFETY EN</a> <a href="#">FL APPL LED LIGHTING EN</a> <a href="#">FLIndustr.CONTROLS EN</a> <a href="#">FL MACHINE SAFETY EN</a> <a href="#">FL HEATING ELECTR EN</a> <a href="#">FL APPL INVERTER EN</a> <a href="#">FL_BASE_STATION_EN</a> <a href="#">FL ELEVATOR EN</a> <a href="#">FL POWER SUPPLY EN</a> <a href="#">FL 72H SAMPLE SER EN</a> <a href="#">PO OMNIMATE EN</a> <a href="#">PO OMNIMATE EN</a>

**BL 3.50/02/90F SN OR BX**

**Weidmüller Interface GmbH & Co. KG**  
 Klingenbergstraße 26  
 D-32758 Detmold  
 Germany

www.weidmueller.com

**Drawings**

**Product image**



**Dimensional drawing**

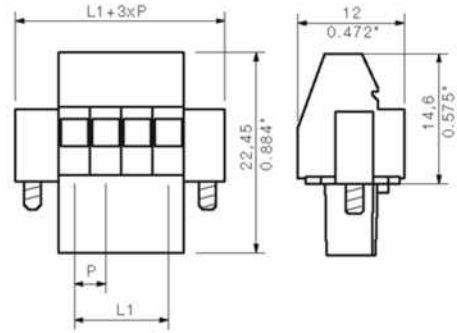

**Graph**

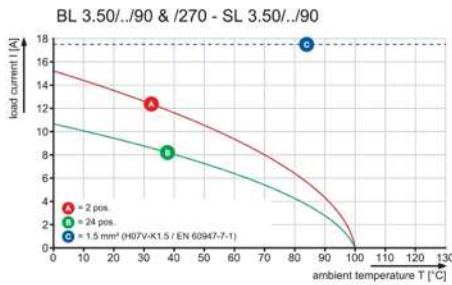

**Graph**

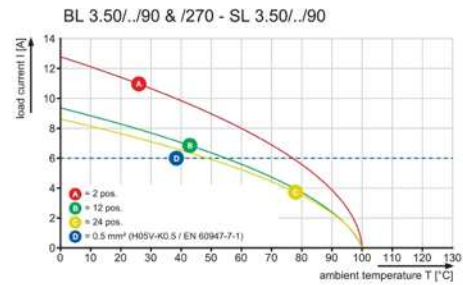

DIE DEUTSCHE VERSION IST VERBINDLICH  
THE GERMAN VERSION IS BINDING

WEITERGABE SOWIE VERVIELFÄLTIGUNG DIESES DOKUMENTS, VERWERTUNG UND MITTEILUNG SEINES INHALTS SIND VERBOTEN, SOWEIT NICHT AUSDRUECKLICH GESTATTET.  
ZUWIDERHANDLUNGEN VERPFLICHTEN ZU SCHADENERSATZ. ALLE RECHTE FUER DEN FALL DER PATENT-, GEBRAUCHSMUSTER- ODER GESCHMACKSMUSTEREINTRAGUNG VORBEHALTEN.  
THE REPRODUCTION, DISTRIBUTION AND UTILIZATION OF THIS DOCUMENT AS WELL AS THE COMMUNICATION OF ITS CONTENTS TO OTHERS WITHOUT EXPLICIT AUTHORIZATION IS PROHIBITED.  
OFFENDERS WILL BE HELD LIABLE FOR THE PAYMENT OF DAMAGES. WEIDMUELLER EXCLUSIVELY RESERVES THE RIGHT TO FILE FOR PATENTS, UTILITY MODELS OR DESIGNS.  
© WEIDMUELLER INTERFACE GmbH & Co.KG

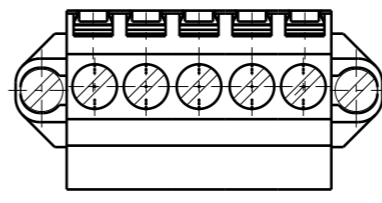
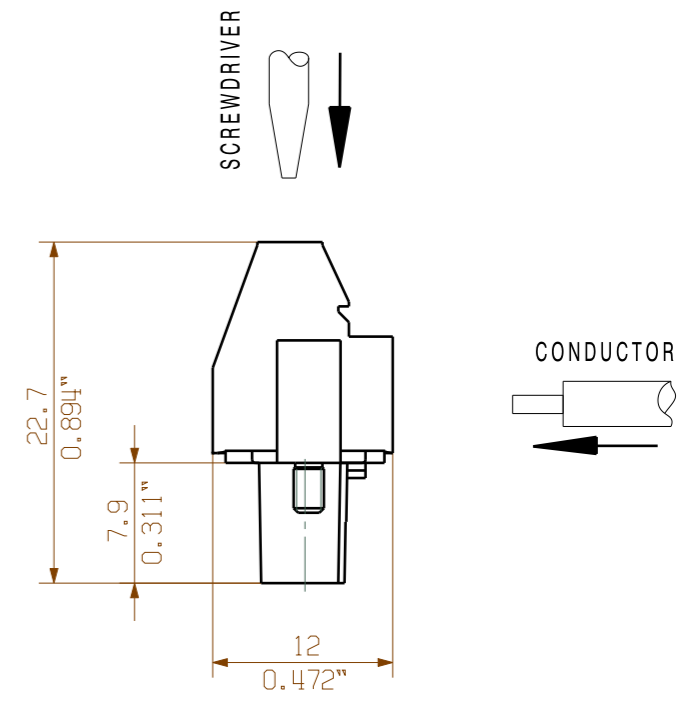

24	80,50	3,169
23	77,00	3,031
22	73,50	2,894
21	70,00	2,756
20	66,50	2,618
19	63,00	2,480
18	59,50	2,343
17	56,00	2,205
16	52,50	2,067
15	49,00	1,929
14	45,50	1,791
13	42,00	1,654
12	38,50	1,516
11	35,00	1,378
10	31,50	1,240
9	28,00	1,102
8	24,50	0,965
7	21,00	0,827
6	17,50	0,689
5	14,00	0,551
4	10,50	0,413
3	7,00	0,276
2	3,50	0,138
n	L1[mm]	L1 [Inch]

BL 3.50/05/90F

For the mounting of PCBs, it should be noted that the rated data given in the catalogue relates only to the connection elements. The necessary creepage and clearance paths must be observed in connection with the respective applicant in accordance with VDE 0110. The current-carrying capacity and pitch tolerance is to be determined according to DIN IEC 326 part 3 very fine.

Weidmüller connectors are tested to the DIN VDE 0627 standard, and are valid for its field of application. Provided that the components are used to the intended purpose, all requirements with respect to the occurring of electrical, mechanical, thermic and corrosive stress will be satisfied.

	METRIC TOLERANCES: X. = ±0.3 X.X = ±0.1 X.XX = ±0.05		CAT.NO.:	
	60340/0 15.09.11 HELIS_MA 01		<b>C 21346</b> 15	
MODIFICATION		DRAWING NO. SHEET 02 OF 03 SHEETS		ISSUE NO.
		DATE: 24.07.2003	NAME: KOWOLLIK_R	<b>BL 3.50/.. /90...</b> BUCHSENSTECKER FEMALE PLUG
SCALE: 5/1		RESPONSIBLE:	LANG_T	
SUPERSEDES:		CHECKED: 15.09.2011	RIEPENHAUSEN_H	
APPROVED:		HECKERT_M	PRODUCT FILE: BL 3.50	7369