

OMNIMATE Signal - series BL/SL 3.50
BL 3.50/03/90 SN BK BX

Weidmüller Interface GmbH & Co. KG
 Klingenbergstraße 16
 D-32758 Detmold
 Germany
 Fon: +49 5231 14-0
 Fax: +49 5231 14-292083
 www.weidmueller.com

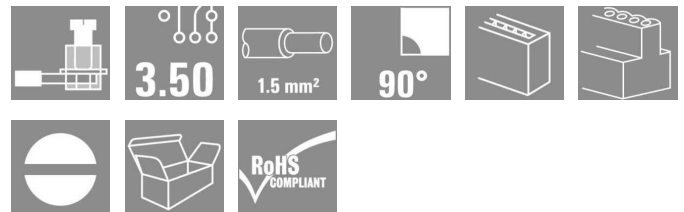

Female connectors with clamping yoke screw system for connecting conductors at 3.50 mm pitch. They provide space for labelling and can be coded.

General ordering data

Type	BL 3.50/03/90 SN BK BX
Order No.	1638790000
Version	PCB plug-in connector, female plug, 3.50 mm, No. of poles: 3, 90°. Clamping yoke connection, Clamping range, rated connection, max.: 1.5 mm², Box
GTIN (EAN)	4008190276331
Qty.	174 pc(s).
Product data	IEC: 320 V / 12 A / 0.2 - 1.5 mm² UL: 300 V / 8 A / AWG 28 - AWG 14
Packaging	Box

**OMNIMATE Signal - series BL/SL 3.50
BL 3.50/03/90 SN BK BX**

Weidmüller Interface GmbH & Co. KG
 Klingenbergstraße 16
 D-32758 Detmold
 Germany
 Fon: +49 5231 14-0
 Fax: +49 5231 14-292083
 www.weidmueller.com

Technical data**Dimensions and weights**

Net weight 3.03 g

System parameters

Product family		Type of connection	
Product family	OMNIMATE Signal - series BL/SL 3.50	Type of connection	Field connection
Wire connection method	Clamping yoke connection	Pitch in mm (P)	3.5 mm
Pitch in inches (P)	0.138 inch	Conductor outlet direction	90°
No. of poles	3	L1 in mm	7 mm
L1 in inches	0.276 inch	Number of rows	1
Pin series quantity	1	Rated cross-section	1.5 mm ²
Touch-safe protection acc. to DIN VDE 57 106	Safe from finger touch	Touch-safe protection acc. to DIN VDE 0470	IP 20
Can be coded	Yes	Stripping length	6 mm
Tightening torque, min.	0.2 Nm	Tightening torque, max.	0.25 Nm
Clamping screw	M 2	Screwdriver blade	0.4 x 2.5
Screwdriver blade standard	DIN 5264	Plugging cycles	25
push-in force/pole	10 N	Withdrawal force per pole	4 N
Packaging	Box		

Material data

Insulating material	PBT	Colour	Black
Colour chart (similar)	RAL 9011	Insulating material group	Illa
CTI	≥ 200	Insulation resistance	≥ 10 ⁸ Ω
UL 94 flammability rating	V-0	Contact material	Cu-Leg
Contact surface	tinned	Layer structure of plug contact	4-8 μm Sn hot-dip tinned
Storage temperature, min.	-25 °C	Storage temperature, max.	55 °C
Max. relative humidity during storage	80 %	Operating temperature, min.	-50 °C
Operating temperature, max.	100 °C	Temperature range, installation, min.	-30 °C
Temperature range, installation, max.	100 °C		

Conductors suitable for connection

Clamping range, rated connection, min.	0.08 mm ²	Clamping range, rated connection, max.	1.5 mm ²
Wire connection cross section AWG, min.	AWG 28	Wire connection cross section AWG, max.	AWG 14
Solid, min. H05(07) V-U	0.2 mm ²	Solid, max. H05(07) V-U	1.5 mm ²
Flexible, min. H05(07) V-K	0.2 mm ²	Flexible, max. H05(07) V-K	1.5 mm ²
w. plastic collar ferrule, DIN 46228 pt 4, min.	0.2 mm ²	w. plastic collar ferrule, DIN 46228 pt 4, max.	1.5 mm ²
w. wire end ferrule, DIN 46228 pt 1, min.	0.2 mm ²	w. wire end ferrule, DIN 46228 pt 1, max.	1.5 mm ²
Plug gauge acc. to EN 60999 a x b; Ø	2.4 mm x 1.5 mm		

OMNIMATE Signal - series BL/SL 3.50 BL 3.50/03/90 SN BK BX

Weidmüller Interface GmbH & Co. KG
Klingenbergstraße 16
D-32758 Detmold
Germany
Fon: +49 5231 14-0
Fax: +49 5231 14-292083
www.weidmueller.com

Technical data

Rated data acc. to IEC

tested acc. to standard	IEC 60664-1, IEC 61984	Rated current, min. no. of poles (Ta = 20°C)	12 A
Rated current, max. no. of poles (Ta = 20°C)	10 A	Rated current, min. no. of poles (Ta = 40°C)	10 A
Rated current, max. no. of poles (Ta = 40°C)	8 A	Rated voltage for surge voltage class / pollution degree II/2	320 V
Rated voltage for surge voltage class / pollution degree III/2	160 V	Rated voltage for surge voltage class / pollution degree III/3	160 V
Rated impulse voltage for surge voltage class/ pollution degree II/2	2.5 kV	Rated impulse voltage for surge voltage class/ pollution degree III/2	2.5 kV
Rated impulse voltage for surge voltage class/ contamination degree III/3	2.5 kV	Short-time withstand current resistance	3 x 1s with 100 A

Rated data acc. to CSA

Institute (CSA)		Certificate No. (CSA)	154685-1318353
Rated voltage (Use group B)	300 V	Rated voltage (use group D)	300 V
Rated current (use group B)	10 A	Rated current (use group D)	10 A
Wire cross-section, AWG, min.	AWG 28	Wire cross-section, AWG, max.	AWG 14
Reference to approval values	Specifications are maximum values, details - see approval certificate.		

Rated data acc. to UL 1059

Institute (UR)		Certificate No. (UR)	E60693
Rated voltage (use group B)	300 V	Rated voltage (use group D)	300 V
Rated current (use group B)	8 A	Rated current (use group D)	8 A
Wire cross-section, AWG, min.	AWG 28	Wire cross-section, AWG, max.	AWG 14
Reference to approval values	Specifications are maximum values, details - see approval certificate.		

Classifications

ETIM 3.0	EC001284	ETIM 4.0	EC002637
ETIM 5.0	EC002637	ETIM 6.0	EC002637
UNSPSC	30-21-18-10	eClass 5.1	27-26-07-04
eClass 6.2	27-26-07-04	eClass 7.1	27-44-04-02
eClass 8.1	27-44-04-02	eClass 9.0	27-44-04-02

Data sheet

**OMNIMATE Signal - series BL/SL 3.50
BL 3.50/03/90 SN BK BX**

Weidmüller Interface GmbH & Co. KG
Klingenbergstraße 16
D-32758 Detmold
Germany
Fon: +49 5231 14-0
Fax: +49 5231 14-292083
www.weidmueller.com

Technical data

Notes

- | | |
|-------|---|
| Notes | <ul style="list-style-type: none"> • Additional colours on request • Gold-plated contact surfaces on request • Rated current related to rated cross-section & min. No. of poles. • Max. outer diameter of the conductor: 2.9 mm • Wire end ferrule without plastic collar to DIN 46228/1 • Wire end ferrule with plastic collar to DIN 46228/4 • P on drawing = pitch • Rated data refer only to the component itself. Clearance and creepage distances to other components are to be designed in accordance with the relevant application standards. |
|-------|---|

IPC conformity	The products are developed, manufactured and delivered according to the internationally recognised IPC-A-610 standard, category "permissible". More extensive demands on the products can be evaluated on request.
----------------	--

Approvals

Approvals



ROHS

Conform

Data sheet

**OMNIMATE Signal - series BL/SL 3.50
BL 3.50/03/90 SN BK BX**

Weidmüller Interface GmbH & Co. KG
Klingenbergstraße 16
D-32758 Detmold
Germany
Fon: +49 5231 14-0
Fax: +49 5231 14-292083
www.weidmueller.com

Drawings

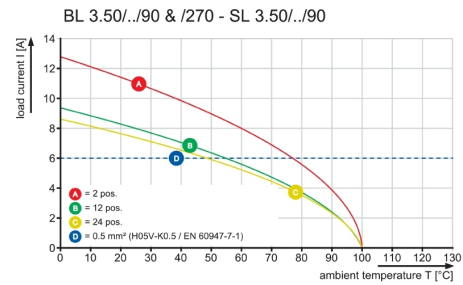
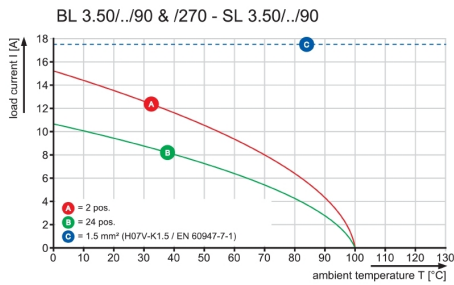
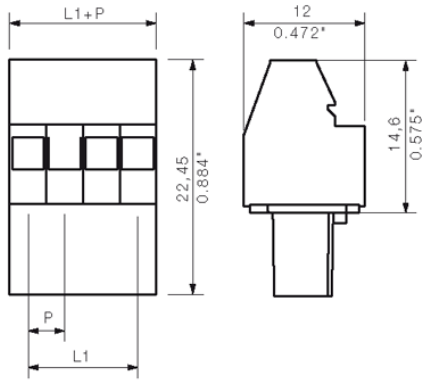

**OMNIMATE Signal - series BL/SL 3.50
BL 3.50/03/90 SN BK BX**

Weidmüller Interface GmbH & Co. KG
Klingenbergstraße 16
D-32758 Detmold
Germany
Fon: +49 5231 14-0
Fax: +49 5231 14-292083
www.weidmueller.com

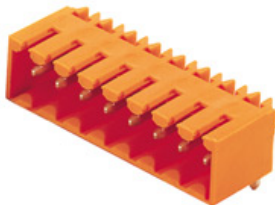
Mating connector (fully pluggable)
SL 3.50/90G

Pin headers for wave soldering in 3.50 mm pitch

- Plugging direction is parallel (90°), straight 180° or angled (135°) to the PCB
- Housing variant: screw flange (F)
- Packed in a cardboard box (BX)
- Pin header can be coded

General ordering data

Type	Order No.	Version	GTIN (EAN)	Qty.	Product data	Packaging
SL	1605080000	PCB plug-in connector, male	4008190088538	100 pc(s).	IEC: 320 V / 17 A	Box
3.50/03/90G		header, closed side, THT			UL: 300 V / 10 A	
3.2SN OR BX		solder connection, 3.50 mm, No. of poles: 3, 90°, Solder pin length (l): 3.2 mm, tinned, Orange, Box				

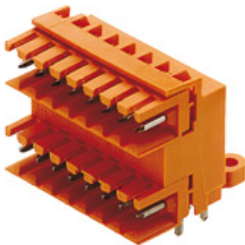
SLD 3.50/90

Two-tier pin header for wave soldering in 3.50 mm pitch. The connector is available in open, closed and flange versions. The male connectors provide space for labelling and can be coded. Packed in a cardboard box.

General ordering data

Type	Order No.	Version	GTIN (EAN)	Qty.	Product data	Packaging
SLD	1633360000	PCB plug-in connector, male	4008190257811	150 pc(s).	IEC: 200 V / 10.5 A	Box
3.50/06/90		header, open side, THT			UL: 300 V / 8 A	
3.2SN OR BX		solder connection, 3.50 mm, No. of poles: 6, 90°, Solder pin length (l): 3.2 mm, tinned, Orange, Box				

**OMNIMATE Signal - series BL/SL 3.50
BL 3.50/03/90 SN BK BX**

Weidmüller Interface GmbH & Co. KG
Klingenbergstraße 16
D-32758 Detmold
Germany
Fon: +49 5231 14-0
Fax: +49 5231 14-292083
www.weidmueller.com

Mating connector (fully pluggable)
SL-SMT 3.5/90G Tape

High-temperature-resistant male header, 3.50 mm pitch.

- **Plugging direction parallel (90°), straight 180° or angled (135°) to PCB**
- **Housing variants: closed side (G), screw flange (F), solder flange (LF) or snap-on solder flange (RF)**
- **Optimised for the SMT process**
- **Pin length 3.2 mm universal for all soldering methods**
- **Pin length 1.5 mm optimised for reflow soldering methods**
- **Packed either in a box (BX) or tape-on-reel (RL)**
- **Male header can be coded**

General ordering data

Type	Order No.	Version	GTIN (EAN)	Qty.	Product data	Packaging
SL-SMT	1761554002	PCB plug-in connector, male	4032248193332	385 pc(s).	IEC: 320 V / 15 A UL: 300 V / 10 A	Tape
3.50/03/90G		header, closed side, THT/ THR solder connection,				(Ø
1.5SN BK RL		3.50 mm, No. of poles: 3, 90°, Solder pin length (l): 1.5 mm, tinned, Black, Tape				330 mm); Rs = 10 ⁹ - 10 ¹² Ω

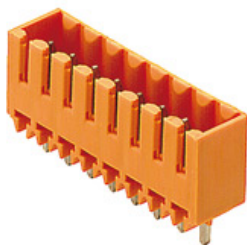
SL 3.50/180G

Pin headers for wave soldering in 3.50 mm pitch

- **Plugging direction is parallel (90°), straight 180° or angled (135°) to the PCB**
- **Housing variant: screw flange (F)**
- **Packed in a cardboard box (BX)**
- **Pin header can be coded**

General ordering data

Type	Order No.	Version	GTIN (EAN)	Qty.	Product data	Packaging
SL	1604480000	PCB plug-in connector, male	4008190049621	100 pc(s).	IEC: 320 V / 17 A UL: 300 V / 10 A	Box
3.50/03/180G		header, closed side, THT solder connection, 3.50				
3.2SN OR BX		mm, No. of poles: 3, 180°				

**OMNIMATE Signal - series BL/SL 3.50
BL 3.50/03/90 SN BK BX**

Weidmüller Interface GmbH & Co. KG
Klingenbergstraße 16
D-32758 Detmold
Germany
Fon: +49 5231 14-0
Fax: +49 5231 14-292083
www.weidmueller.com

Mating connector (fully pluggable)

Solder pin length (l): 3.2
mm, tinned, Orange, Box

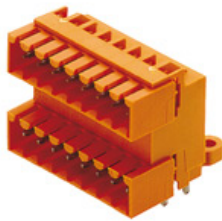
SLD 3.50/90G

Two-tier pin header for wave soldering in 3.50 mm pitch. The connector is available in open, closed and flange versions. The male connectors provide space for labelling and can be coded. Packed in a cardboard box.

General ordering data

Type	Order No.	Version	GTIN (EAN)	Qty.	Product data	Packaging
SLD	1633590000	PCB plug-in connector, male	4008190258047	50 pc(s).	IEC: 200 V / 10.5 A	Box
3.50/06/90G		header, closed side, THT			UL: 300 V / 8 A	
3.2SN OR BX		solder connection, 3.50 mm, No. of poles: 6, 90°, Solder pin length (l): 3.2 mm, tinned, Orange, Box				

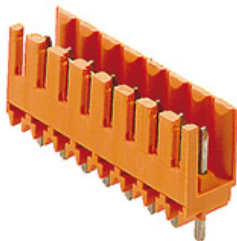
SL 3.50/180

Pin headers for wave soldering in 3.50 mm pitch

- Plugging direction is parallel (90°), straight 180° or angled (135°) to the PCB
- Housing variant: screw flange (F)
- Packed in a cardboard box (BX)
- Pin header can be coded

General ordering data

Type	Order No.	Version	GTIN (EAN)	Qty.	Product data	Packaging
SL	1604780000	PCB plug-in connector, male	4008190014322	100 pc(s).	IEC: 320 V / 17 A	Box
3.50/03/180		header, open side, THT			UL: 300 V / 10 A	
3.2SN OR BX		solder connection, 3.50 mm, No. of poles: 3, 180°, Solder pin length (l): 3.2 mm, tinned, Orange, Box				

**OMNIMATE Signal - series BL/SL 3.50
BL 3.50/03/90 SN BK BX**

Weidmüller Interface GmbH & Co. KG
Klingenbergstraße 16
D-32758 Detmold
Germany
Fon: +49 5231 14-0
Fax: +49 5231 14-292083
www.weidmuller.com

Mating connector (fully pluggable)**SL-THR 3.5/135F**

High-temperature-resistant male header, 3.50 mm pitch.

- **Plugging direction parallel (90°), straight 180° or angled (135°) to PCB**
- **Housing variants: closed side (G), screw flange (F), solder flange (LF) or snap-on solder flange (RF)**
- **Optimised for the SMT process**
- **Pin length 3.2 mm universal for all soldering methods**
- **Pin length 1.5 mm optimised for reflow soldering methods**
- **Packed either in a box (BX) or tape-on-reel (RL)**
- **Male header can be coded**

General ordering data

Type	Order No.	Version	GTIN (EAN)	Qty.	Product data	Packaging
SL-SMT	1003520000	PCB plug-in connector, male	4032248700158	102 pc(s).	IEC: 320 V / 15 A UL: 300 V / 10 A	Box
3.50/03/135F		header, Flange, THT/THR				
3.2SN BK BX		solder connection, 3.50 mm, No. of poles: 3, 135°, Solder pin length (l): 3.2 mm, tinned, Black, Box				

SL-SMT 3.5/180G Tape

High-temperature-resistant male header, 3.50 mm pitch.

- **Plugging direction parallel (90°), straight 180° or angled (135°) to PCB**
- **Housing variants: closed side (G), screw flange (F), solder flange (LF) or snap-on solder flange (RF)**
- **Optimised for the SMT process**
- **Pin length 3.2 mm universal for all soldering methods**
- **Pin length 1.5 mm optimised for reflow soldering methods**
- **Packed either in a box (BX) or tape-on-reel (RL)**
- **Male header can be coded**

General ordering data

Type	Order No.	Version	GTIN (EAN)	Qty.	Product data	Packaging
SL-SMT	1752994002	PCB plug-in connector, male	4032248193103	265 pc(s).	IEC: 320 V / 15 A UL: 300 V / 10 A	Tape
3.50/03/180G		header, closed side, THT/				(Ø
1.5SN BK RL		THR solder connection, 3.50 mm, No. of poles: 3,				330 mm);

Creation date April 20, 2016 5:47:39 PM CEST

OMNIMATE Signal - series BL/SL 3.50 BL 3.50/03/90 SN BK BX

Weidmüller Interface GmbH & Co. KG
Klingenbergstraße 16
D-32758 Detmold
Germany
Fon: +49 5231 14-0
Fax: +49 5231 14-292083
www.weidmueller.com

Mating connector (fully pluggable)

180°, Solder pin length (l):
1.5 mm, tinned, Black, Tape
(Ø 330 mm); Rs = 10⁹ -
10¹² Ω

Rs
=
10⁹
-
10¹²
Ω

SL 3.50/90

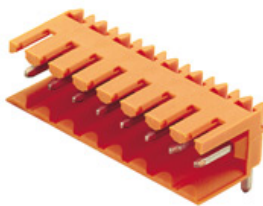

Pin headers for wave soldering in 3.50 mm pitch

- Plugging direction is parallel (90°), straight 180° or angled (135°) to the PCB
- Housing variant: screw flange (F)
- Packed in a cardboard box (BX)
- Pin header can be coded

General ordering data

Type	Order No.	Version	GTIN (EAN)	Qty.	Product data	Packaging
SL	1597220000	PCB plug-in connector, male	4008190121792	100 pc(s).	IEC: 320 V / 17 A	Box
3.50/03/90		header, open side, THT			UL: 300 V / 10 A	
3.2SN OR BX		solder connection, 3.50 mm, No. of poles: 3, 90°, Solder pin length (l): 3.2 mm, tinned, Orange, Box				

SL-SMT 3.5/90G Box



High-temperature-resistant male header, 3.50 mm pitch.

- **Plugging direction parallel (90°), straight 180° or angled (135°) to PCB**
- **Housing variants: closed side (G), screw flange (F), solder flange (LF) or snap-on solder flange (RF)**
- **Optimised for the SMT process**
- **Pin length 3.2 mm universal for all soldering methods**
- **Pin length 1.5 mm optimised for reflow soldering methods**
- **Packed either in a box (BX) or tape-on-reel (RL)**
- **Male header can be coded**

General ordering data

Type	Order No.	Version	GTIN (EAN)	Qty.	Product data	Packaging
SL-SMT	1761552001	PCB plug-in connector, male	4032248132041	100 pc(s).	IEC: 320 V / 15 A	Box
3.50/03/90G		header, closed side, THT/			UL: 300 V / 10 A	
1.5SN BK BX		THR solder connection,				

Creation date April 20, 2016 5:47:39 PM CEST

**OMNIMATE Signal - series BL/SL 3.50
BL 3.50/03/90 SN BK BX**

Weidmüller Interface GmbH & Co. KG
 Klingenbergstraße 16
 D-32758 Detmold
 Germany
 Fon: +49 5231 14-0
 Fax: +49 5231 14-292083
 www.weidmueller.com

Mating connector (fully pluggable)

		3.50 mm, No. of poles: 3, 90°, Solder pin length (l): 1.5 mm, tinned, Black, Box		
SL-SMT	1841640000	PCB plug-in connector, male	4032248352791 100 pc(s).	IEC: 320 V / 15 A UL: 300 V / 10 A
3.50/03/90G		header, closed side, THT/ THR solder connection,		Box
3.2SN BK BX		3.50 mm, No. of poles: 3, 90°, Solder pin length (l): 3.2 mm, tinned, Black, Box		

**OMNIMATE Signal - series BL/SL 3.50
BL 3.50/03/90 SN BK BX**

Weidmüller Interface GmbH & Co. KG
Klingenbergstraße 16
D-32758 Detmold
Germany
Fon: +49 5231 14-0
Fax: +49 5231 14-292083
www.weidmuller.com

Mating connector (conditionally pluggable)
SL-SMT 3.5/90F Box

High-temperature-resistant male header, 3.50 mm pitch.

- **Plugging direction parallel (90°), straight 180° or angled (135°) to PCB**
- **Housing variants: closed side (G), screw flange (F), solder flange (LF) or snap-on solder flange (RF)**
- **Optimised for the SMT process**
- **Pin length 3.2 mm universal for all soldering methods**
- **Pin length 1.5 mm optimised for reflow soldering methods**
- **Packed either in a box (BX) or tape-on-reel (RL)**
- **Male header can be coded**

General ordering data

Type	Order No.	Version	GTIN (EAN)	Qty.	Product data	Packaging
SL-SMT	1842090000	PCB plug-in connector, male	4032248353446	100 pc(s).	IEC: 320 V / 15 A	Box
3.50/03/90F		header, Flange, THT/THR			UL: 300 V / 10 A	
3.2SN BK BX		solder connection, 3.50 mm, No. of poles: 3, 90°, Solder pin length (l): 3.2 mm, tinned, Black, Box				

SL-SMT 3.5/90LF Tape

High-temperature-resistant male header, 3.50 mm pitch.

- **Plugging direction parallel (90°), straight 180° or angled (135°) to PCB**
- **Housing variants: closed side (G), screw flange (F), solder flange (LF) or snap-on solder flange (RF)**
- **Optimised for the SMT process**
- **Pin length 3.2 mm universal for all soldering methods**
- **Pin length 1.5 mm optimised for reflow soldering methods**
- **Packed either in a box (BX) or tape-on-reel (RL)**
- **Male header can be coded**

General ordering data

Type	Order No.	Version	GTIN (EAN)	Qty.	Product data	Packaging
SL-SMT	1805320000	PCB plug-in connector, male	4032248269570	385 pc(s).	IEC: 320 V / 15 A	Tape
3.50/03/90LF		header, Solder flange, THT/			UL: 300 V / 10 A	(Ø
1.5SN BK RL		THR solder connection, 3.50 mm, No. of poles: 3,				330 mm);

Creation date April 20, 2016 5:47:39 PM CEST

OMNIMATE Signal - series BL/SL 3.50 BL 3.50/03/90 SN BK BX

Weidmüller Interface GmbH & Co. KG
Klingenbergstraße 16
D-32758 Detmold
Germany
Fon: +49 5231 14-0
Fax: +49 5231 14-292083
www.weidmueller.com

Mating connector (conditionally pluggable)

90°, Solder pin length (l):
1.5 mm, tinned, Black, Tape
(Ø 330 mm); Rs = 10⁹ -
10¹² Ω

Rs
=
10⁹
-
10¹²
Ω

SL 3.50/135F

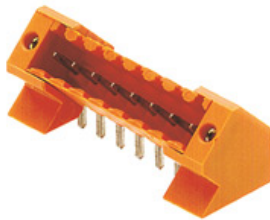

Pin headers for wave soldering in 3.50 mm pitch

- Plugging direction is parallel (90°), straight 180° or angled (135°) to the PCB
- Housing variant: screw flange (F)
- Packed in a cardboard box (BX)
- Pin header can be coded

General ordering data

Type	Order No.	Version	GTIN (EAN)	Qty.	Product data	Packaging
SL	1643340000	PCB plug-in connector, male	4008190282103	102 pc(s).	IEC: 320 V / 15 A	Box
3.50/03/135F		header, Flange, THT solder			UL: 300 V / 10 A	
3.2SN OR BX		connection, 3.50 mm, No. of poles: 3, 135°, Solder pin length (l): 3.2 mm, tinned, Orange, Box				

SL-SMT 3.5/180G Box



High-temperature-resistant male header, 3.50 mm pitch.

- **Plugging direction parallel (90°), straight 180° or angled (135°) to PCB**
- **Housing variants: closed side (G), screw flange (F), solder flange (LF) or snap-on solder flange (RF)**
- **Optimised for the SMT process**
- **Pin length 3.2 mm universal for all soldering methods**
- **Pin length 1.5 mm optimised for reflow soldering methods**
- **Packed either in a box (BX) or tape-on-reel (RL)**
- **Male header can be coded**

General ordering data

Type	Order No.	Version	GTIN (EAN)	Qty.	Product data	Packaging
SL-SMT	1842330000	PCB plug-in connector, male	4032248353675	100 pc(s).	IEC: 320 V / 15 A	Box
3.50/03/180G		header, closed side, THT/			UL: 300 V / 10 A	
3.2SN BK BX		THR solder connection,				

Creation date April 20, 2016 5:47:39 PM CEST

**OMNIMATE Signal - series BL/SL 3.50
BL 3.50/03/90 SN BK BX**

Weidmüller Interface GmbH & Co. KG
Klingenbergstraße 16
D-32758 Detmold
Germany
Fon: +49 5231 14-0
Fax: +49 5231 14-292083
www.weidmueller.com

Mating connector (conditionally pluggable)

		3.50 mm, No. of poles: 3, 180°, Solder pin length (l): 3.2 mm, tinned, Black, Box		
SL-SMT	1752992001	PCB plug-in connector, male	4032248130917 100 pc(s).	IEC: 320 V / 15 A UL: 300 V / 10 A
3.50/03/180G		header, closed side, THT/ THR solder connection,		Box
1.5SN BK BX		3.50 mm, No. of poles: 3, 180°, Solder pin length (l): 1.5 mm, tinned, Black, Box		

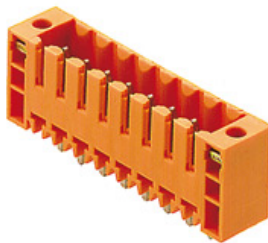
SL 3.50/180F

Pin headers for wave soldering in 3.50 mm pitch

- Plugging direction is parallel (90°), straight 180° or angled (135°) to the PCB
- Housing variant: screw flange (F)
- Packed in a cardboard box (BX)
- Pin header can be coded

General ordering data

Type	Order No.	Version	GTIN (EAN)	Qty.	Product data	Packaging
SL	1607510000	PCB plug-in connector, male	4008190163907 100 pc(s).		IEC: 320 V / 17 A UL: 300 V / 10 A	Box
3.50/03/180F		header, Flange, THT solder connection, 3.50 mm, No. of poles: 3, 180°, Solder pin length (l): 3.2 mm, tinned, Orange, Box				

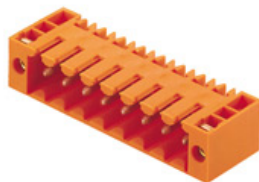
SL 3.50/90F

Pin headers for wave soldering in 3.50 mm pitch

- Plugging direction is parallel (90°), straight 180° or angled (135°) to the PCB
- Housing variant: screw flange (F)
- Packed in a cardboard box (BX)
- Pin header can be coded

General ordering data

Type	Order No.	Version	GTIN (EAN)	Qty.	Product data	Packaging
SL	1607050000	PCB plug-in connector, male	4008190055257 100 pc(s).		IEC: 320 V / 17 A UL: 300 V / 10 A	Box
3.50/03/90F		header, Flange, THT solder connection, 3.50 mm, No. of poles: 3, 90°, Solder pin length (l): 3.2 mm, tinned, Orange, Box				

**OMNIMATE Signal - series BL/SL 3.50
BL 3.50/03/90 SN BK BX**

Weidmüller Interface GmbH & Co. KG
Klingenbergstraße 16
D-32758 Detmold
Germany
Fon: +49 5231 14-0
Fax: +49 5231 14-292083
www.weidmueller.com

Mating connector (conditionally pluggable)
SL-SMT 3.5/180LF Tape

High-temperature-resistant male header, 3.50 mm pitch.

- **Plugging direction parallel (90°), straight 180° or angled (135°) to PCB**
- **Housing variants: closed side (G), screw flange (F), solder flange (LF) or snap-on solder flange (RF)**
- **Optimised for the SMT process**
- **Pin length 3.2 mm universal for all soldering methods**
- **Pin length 1.5 mm optimised for reflow soldering methods**
- **Packed either in a box (BX) or tape-on-reel (RL)**
- **Male header can be coded**

General ordering data

Type	Order No.	Version	GTIN (EAN)	Qty.	Product data	Packaging
SL-SMT	1805230000	PCB plug-in connector, male	4032248269105	265 pc(s).	IEC: 320 V / 15 A	Tape
3.50/03/180LF		header, Solder flange, THT/ THR solder connection,			UL: 300 V / 10 A	(Ø
1.5SN BK RL		3.50 mm, No. of poles: 3, 180°, Solder pin length (l): 1.5 mm, tinned, Black, Tape				330 mm); Rs = 10 ⁹ - 10 ¹² Ω

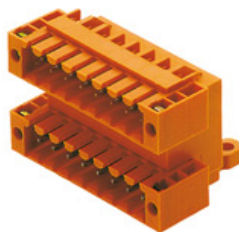
SLD 3.50/90F

Two-tier pin header for wave soldering in 3.50 mm pitch. The connector is available in open, closed and flange versions. The male connectors provide space for labelling and can be coded. Packed in a cardboard box.

General ordering data

Type	Order No.	Version	GTIN (EAN)	Qty.	Product data	Packaging
SLD	1633820000	PCB plug-in connector, male	4008190258276	50 pc(s).	IEC: 200 V / 10.5 A	Box
3.50/06/90F		header, Flange, THT solder connection, 3.50 mm, No. of poles: 6, 90°, Solder pin			UL: 300 V / 8 A	
3.2SN OR BX						

**OMNIMATE Signal - series BL/SL 3.50
BL 3.50/03/90 SN BK BX**

Weidmüller Interface GmbH & Co. KG
Klingenbergstraße 16
D-32758 Detmold
Germany
Fon: +49 5231 14-0
Fax: +49 5231 14-292083
www.weidmueller.com

Mating connector (conditionally pluggable)

length (l): 3.2 mm, tinned,
Orange, Box

SL-SMT 3.5/180LF Box

High-temperature-resistant male header, 3.50 mm pitch.

- **Plugging direction parallel (90°), straight 180° or angled (135°) to PCB**
- **Housing variants: closed side (G), screw flange (F), solder flange (LF) or snap-on solder flange (RF)**
- **Optimised for the SMT process**
- **Pin length 3.2 mm universal for all soldering methods**
- **Pin length 1.5 mm optimised for reflow soldering methods**
- **Packed either in a box (BX) or tape-on-reel (RL)**
- **Male header can be coded**

General ordering data

Type	Order No.	Version	GTIN (EAN)	Qty.	Product data	Packaging
SL-SMT 3.50/03/180LF 1.5SN BK BX	1804710000	PCB plug-in connector, male header, Solder flange, THT/ THR solder connection, 3.50 mm, No. of poles: 3, 180°, Solder pin length (l): 1.5 mm, tinned, Black, Box	4032248268528	100 pc(s).	IEC: 320 V / 15 A UL: 300 V / 10 A	Box
SL-SMT 3.50/03/180LF 3.2SN BK BX	1842550000	PCB plug-in connector, male header, Solder flange, THT/ THR solder connection, 3.50 mm, No. of poles: 3, 180°, Solder pin length (l): 3.2 mm, tinned, Black, Box	4032248353910	100 pc(s).	IEC: 320 V / 15 A UL: 300 V / 10 A	Box

**OMNIMATE Signal - series BL/SL 3.50
BL 3.50/03/90 SN BK BX**

Weidmüller Interface GmbH & Co. KG
Klingenbergstraße 16
D-32758 Detmold
Germany
Fon: +49 5231 14-0
Fax: +49 5231 14-292083
www.weidmueller.com

Mating connector (conditionally pluggable)
SL-SMT 3.5/90LF Box

High-temperature-resistant male header, 3.50 mm pitch.

- **Plugging direction parallel (90°), straight 180° or angled (135°) to PCB**
- **Housing variants: closed side (G), screw flange (F), solder flange (LF) or snap-on solder flange (RF)**
- **Optimised for the SMT process**
- **Pin length 3.2 mm universal for all soldering methods**
- **Pin length 1.5 mm optimised for reflow soldering methods**
- **Packed either in a box (BX) or tape-on-reel (RL)**
- **Male header can be coded**

General ordering data

Type	Order No.	Version	GTIN (EAN)	Qty.	Product data	Packaging
SL-SMT 3.50/03/90LF 1.5SN BK BX	1804950000	PCB plug-in connector, male header, Solder flange, THT/ THR solder connection, 3.50 mm, No. of poles: 3, 90°, Solder pin length (l): 1.5 mm, tinned, Black, Box	4032248268856	100 pc(s).	IEC: 320 V / 15 A UL: 300 V / 10 A	Box
SL-SMT 3.50/03/90LF 3.2SN BK BX	1841870000	PCB plug-in connector, male header, Solder flange, THT/ THR solder connection, 3.50 mm, No. of poles: 3, 90°, Solder pin length (l): 3.2 mm, tinned, Black, Box	4032248353224	100 pc(s).	IEC: 320 V / 15 A UL: 300 V / 10 A	Box

**OMNIMATE Signal - series BL/SL 3.50
BL 3.50/03/90 SN BK BX**

Weidmüller Interface GmbH & Co. KG
Klingenbergstraße 16
D-32758 Detmold
Germany
Fon: +49 5231 14-0
Fax: +49 5231 14-292083
www.weidmueller.com

Mating connector (conditionally pluggable)
SL-SMT 3.5/180F Box

High-temperature-resistant male header, 3.50 mm pitch.

- **Plugging direction parallel (90°), straight 180° or angled (135°) to PCB**
- **Housing variants: closed side (G), screw flange (F), solder flange (LF) or snap-on solder flange (RF)**
- **Optimised for the SMT process**
- **Pin length 3.2 mm universal for all soldering methods**
- **Pin length 1.5 mm optimised for reflow soldering methods**
- **Packed either in a box (BX) or tape-on-reel (RL)**
- **Male header can be coded**

General ordering data

Type	Order No.	Version	GTIN (EAN)	Qty.	Product data	Packaging
SL-SMT 3.50/03/180F 1.5SN BK BX	1760972001	PCB plug-in connector, male header, Flange, THT/THR solder connection, 3.50 mm, No. of poles: 3, 180°, Solder pin length (l): 1.5 mm, tinned, Black, Box	4032248131549	100 pc(s).	IEC: 320 V / 15 A UL: 300 V / 10 A	Box
SL-SMT 3.50/03/180F 3.2SN BK BX	1842780000	PCB plug-in connector, male header, Flange, THT/THR solder connection, 3.50 mm, No. of poles: 3, 180°, Solder pin length (l): 3.2 mm, tinned, Black, Box	4032248354146	100 pc(s).	IEC: 320 V / 15 A UL: 300 V / 10 A	Box

Addresses worldwide

Let's connect.

- AE United Arab Emirates**
Weidmüller Middle East FZE
Warehouse Q3-79
SAIF-Zone
P.O. BOX 8591
Sharjah
Telephone number +971 65572723
Fax number +971 65572724
wme.info@weidmueller.com
- AO Angola**
Please contact
Phambili Interface
South Africa
- AR Argentina**
CPI SA
Bauness 2660
C1431DOF Buenos Aires
Telephone number +54 11 4523 8008
Fax number +54 11 4522 0546
info@cpi.com.ar
www.cpi.com.ar
- AT Austria**
Weidmüller GmbH
IZ NOE Süd Straße 2b, Obj
M 59
2355 Wiener Neudorf
Telephone number +43 2236 67080
Fax number +43 2236 6708-899
office.at@weidmueller.com
www.weidmueller.com
- AU Australia**
Weidmüller Pty. Ltd.
PO BOX 6944
Huntingwood 2148
Huntingwood Drive 43
Huntingwood NSW 2148
Telephone number +61 2 9671 9999
Fax number +61 2 9671 9911
info@weidmuller.com.au
www.weidmuller.com.au
- AZ Azerbaijan**
Representative Office
Weidmüller Interface
Demirchi Tower, 4th floor
37, Khojali ave.
AZ 1025 Baku
Telephone number +994 12 488 80 36
Fax number +994 12 488 80 37
rashad.mahmudov@weidmueller.com
- BA Bosnia and Herzegovina**
Please contact
our Representative Office
Weidmüller Interface GmbH
& Co. KG
Serbia

or

BIG electric d.o.o
Mladena Stojanovića 117A
78000 Banja Luka
Telephone number +387 51926277
Fax number +387 51926277
bigelectric@blic.net
www.bigelectric.ba
- BE Belgium**
Weidmüller Benelux B. V.
Mechelsesteenweg 519 bus
6 an 7
1930 Nossegem
Telephone number +32 2 752 40 70
Fax number +32 2 751 36 06
info@weidmueller.be
www.weidmueller.be
- BG Bulgaria**
Weid-Bul EOOD
Bul. "Kliment Ohridski" 13
1756 Sofia
Telephone number +359 2 963 2560
Fax number +359 2 963 1098
sofia@weidbul.com
www.weidbul.com
- BH Bahrain**
Khayber Trading Company
P.O Box 1976
Manama
Telephone number +973 720747
Fax number +973 720331
khayber@batelco.com.bh
- BR Brazil**
Weidmüller Conexel do Brasil
Conexões Elétricas Ltda.
Av. Presidente Juscelino, 642
- Piraporinha
Diadema, São Paulo
09950-370
Telephone number +55 (11) 4366-9600
Fax number +55 (11) 4362-1677
vendas@weidmueller.com.br
www.weidmueller.com.br
- BW Botswana**
Please contact
Phambili Interface
South Africa
- BY Belarus**
TECHNIKON Ltd.
Nezavisimosti pr. 177-9
220125 Minsk
Telephone number +375 17 393-11-77
Fax number +375 17 3930080
wm@technikon.by
- CA Canada**
W Interconnections Canada
Inc.
10 Spy Court
Markham Ontario L3R 5H6
Telephone number +1 (905) 475-1507 Ext. 9836
Fax number +1 (905) 475-2798
support@weidmuller.ca
www.weidmuller.ca
- CG Congo**
Please contact
Phambili Interface
South Africa
- CH Switzerland**
Weidmüller Schweiz AG
Rundbuckstraße 2
82 12 Neuhausen am
Rheinfall SH
Telephone number +41 52 674 07 07
Fax number +41 52 674 07 08
info@weidmueller.ch
www.weidmueller.ch
- CL Chile**
ATS - INTECH
María Luisa Santander 0475
Santiago
Providencia 7500859
Telephone number +56 2 341 1271
Fax number +56 2 341 1275
felipe@atsintech.com
www.atsintech.com

CPI CHILE LTDA
Av. Presidente Frei Montalva
6001, 47 complejo el cortijo
Santiago - Conchalí
Telephone number +562 963 8440
Fax number +562 963 8440
cpi@cpichile.cl
www.cpichile.cl
- CN China**
Weidmüller Interface
(Shanghai) Co. Ltd.
100 Yutong Road
25 F, BM Intercontinental
Business Center
200070 Shanghai
Telephone number +86 21-22195008
Fax number +86 21-22195009
customer.hotline@weidmueller.com.cn
www.weidmueller.com.cn
- CO Colombia**
Automatización Avanzada
S. A.
Carrera 97 No., 24 c - 23
Bodega 4
110911 Bogotá-D.C.
Telephone number +57 (1) 547-8510
Fax number +57 (1) 422-3044
comercial@automatizacionavanzada.com
www.automatizacionavanzada.com
- CR Costa Rica**
ELVATRON S. A.
la Uruca 400 Norte Banco
Costa Rica
San Jose Costa Rica
Telephone number +506 2961-060
Fax number +506 5200-609
dirk.haase@elvatron.com
www.elvatron.com
- CZ Czech Republic**
Weidmüller s.r.o.
Lomnického 5/1705
140 00 Praha 4
Telephone number +420 244 001 400
Fax number +420 244 001 499
office@weidmueller.cz
www.weidmueller.cz
- DE Germany**
Weidmüller GmbH & Co. KG
Ohmstraße 9
32758 Detmold
Postfach 30 54
32720 Detmold
Telephone number +49 5231 1428-0
Fax number +49 5231 14-292083
weidmuller@weidmueller.de
www.weidmueller.de
- DK Denmark**
Weidmüller Danmark
Vallensbækvej 18A
2605 Brøndby
Telephone number +45 27747800
kundeservice@weidmuller.dk
www.weidmuller.dk
- DZ Algeria**
SARL INTER ELECTRIC
1a Angles des Rues Okba Ibn
Nafaa et Hassi Beida
2300 Annaba
Telephone number
Fax number
contact@inter-electric.com
- EC Ecuador**
Elsystec S. A., Electricidad
Sistemas y Tecnología
Vasco de Contreras N35-251 y
Mañosa
Quito - Pichincha
Telephone number +593 22456510
Fax number +593 22456755
Elsystec@uio.satnet.net
- EE Estonia**
Please contact
our Representative Office
Weidmüller Interface GmbH
& Co. KG
Latvia

or

Soots Interface OÜ
Pärnu mnt 142
11317 Tallinn
Telephone number +372 609 6933
Fax number
info@sootsinterface.ee
www.sootsinterface.ee
- EG Egypt**
Standard Electric (OMEGA)
1, Abdelhamid Badawy Street
Heliopolis
Cairo
Telephone number +202 21805600
stdelec@rite.com
- ES Spain**
Weidmüller, S. A.
Narcís Monturiol 11-13, Pol.
Ind. Sudoeste
8960 Sant Just
Desvern - Barcelona
Telephone number +34 934 803 386
Fax number +34 933 718 055
weidmuller@weidmuller.es
www.weidmuller.es
- FI Finland**
Weidmüller Suomi,
Weidmüller Aktiebolagetin
sivuliike
Koy Plaza Vivace
Äyritie 8C
FI 15100 Vantaa
Telephone number +358 20 7351300
Fax number +358 800 114 667
asiakaspalvelu@weidmuller.fi
www.weidmuller.fi
- FR France**
Weidmüller E. U. R. L.
12, Chaussée Jules César
BP 263 Osny
95523 Cergy-Pontoise Cedex
Telephone number +33 1 34 24 55 00
Fax number +33 1 34 24 55 01
mail@weidmuller.fr
- GB Great Britain**
Weidmüller Ltd.
Klippon House
Centurion Court Office Park,
Meridian East, Meridian
Business Park
Leicester
LE19 1TP
Telephone number +44 116 282 3470
Fax number +44 116 289 3582
marketing@weidmuller.co.uk
www.weidmuller.co.uk
- GE Georgia**
Please contact
our Representative Office
Weidmüller Interface
Azerbaijan.
- GH Ghana**
Please contact
our Representative Office
Weidmüller Interface GmbH
& Co. KG
South Africa.
- GR Greece**
G.A. Solutions
Ippokratous 11 Metamorfosi
144 52 Athen
Telephone number +30 210 2823233
Fax number +30 210 2823233
info@weidmuller.gr
www.weidmuller.gr
- GT Guatemala**
Prestelectro, Prestegard
Electro, S.A.
Avenida Petapa 44-22,
Zona 12
Guatemala City
Telephone number +502 2442-3346
Fax number +502 2476-8945
ventas@prestelectro.com
- HK Hong Kong**
Weidmüller (Hong Kong)
Limited Co. Ltd.
Unit 1617, Metropolis Tower
No. 10 Metropolis Drive,
Hunghom, Kowloon
Telephone number +852 3154 8088
Fax number +852 31548099
Info-hk@weidmueller.com.hk
- HR Croatia**
ElektroPARTNER d.o.o.
Slavonska avenija 24/6
HR-10000 Zagreb
Telephone number +385 (1) 6184 793
Fax number +385 (1) 6184 795
elektropartner@zg.t-com.hr
www.elektropartner.hr
- HU Hungary**
Weidmüller Kereskedelmi Kft.
Budapest
Gubacsi út 6.
1097
Telephone number +36 1 382 7700
Fax number +36 1 382 7701
info@weidmueller.hu
www.weidmueller.hu
- ID Indonesia**
PT. Nego Electrindo
Ruko Mega Grosir Cempaka
Mas Blok I No. 20 – 22
Jakarta 10640
Telephone number +62 21 42882255
Fax number +62 21 42882266
sales@negoelectrindo.co.id
- IE Ireland**
Please contact
Weidmüller Ltd.
Great Britain
- IL Israel**
A. U. Shay Ltd.
23/25, Embar Street
49222 Petach-Tikva
P.O. Box 1 00 49
49222 Petach-Tikva
Telephone number +972 3-923-3601
Fax number +972 3-923-4601
shay@uriel-shay.com
www.uriel-shay.com

ATEKA Ltd.
4, Ha Tavor lane Industrial
area Segula
49691 Petach-Tikva
P.O. Box 4710
Petach-Tikva
Telephone number +972 73-200-1311
Fax number +972 3-924 4245
marketing@ateka.co.il
www.ateka.co.il
- IN India**
Representative Office
Weidmüller Electronics India
Pvt. Ltd.
12th Lane North Avenue, Opp
Joggers Park,
Kalyani Nagar, Pune
411 006
Telephone number +91 20-41290090
wmi@weidmueller.in
www.weidmueller.com
- IS Iceland**
Samey Automation Center
Lýngas 13
210 Garoabaer
Telephone number +354 510 5200
Fax number +354 510 5201
Samey@samey.is
www.samey.is
- IT Italy**
Weidmüller S. r.l.
Via Albert Einstein 4
20092 Cinisello
Balsamo Milano
Telephone number +39 02 660681
Fax number +39 02 6124945
weidmuller@weidmuller.it
www.weidmuller.it
- JM Jamaica**
Please contact
W Interconnections Inc.
United States
- JO Jordan**
Trans Jordan for Electro
PO Box 33 06 07
Amman
Telephone number +962 6 533 2020
Fax number +962 6 533 5800
transjordan@batelco.jo



You can find all Weidmüller addresses and your local contact on the internet at: www.weidmueller.com/countries

Sales company

Representation abroad

without representation abroad

Let's connect.

- JP Japan**
Nihon Weidmüller Co. Ltd.
Sphere Tower Tennoz 2-2-8
Higashi-Shinagawa,
Shinagawa-ku
Tokyo
140-0002
Telephone number +81 3
6711 5300
Fax number +81 3 6711
5333
weidmullerjapan@weidmueller.co.jp
www.weidmueller.co.jp
- KE Kenya**
Please contact
our Representative Office
Weidmüller Interface GmbH
& Co. KG
South Africa.
- KG Kyrgyzstan**
Please contact
our Representative Office
Weidmüller Interface
Azerbaijan.
- KR Korea**
Weidmüller Korea Co. Ltd.
9th floor
429, Teheran-ro, Gangnam-Gu
Seoul 135-721
Telephone number +82
2-516-0003
Fax number +82 2-516-0090
info@weidmueller.co.kr
www.weidmueller.co.kr
- KW Kuwait**
Kana Controls General Trading
& Contracting Co. W. L. L.
Al Rai Industrial Area, Plot
28-30, St. 31
13016 Safat
B.P. 25593
Telephone number +965
4741373
Fax number +965 4741537
info@kanacontrols.com
- KZ Kazakhstan**
Please contact
Weidmüller Group
Russia
- LB Lebanon**
Progress Engineering &
Trading Enterprises
Al Nahr Street
Beirut 11-1111
Telephone number +961 1
444 664
Fax number +961 1 561 880
progress@inco.com.lb
- LT Lithuania**
Please contact
our Representative Office
Weidmüller Interface GmbH
& Co. KG
Latvia
- or
- ELEKTROS IRANGA
Tinklu g. 29 a
LT-5319 Panevezys
Telephone number +370 (45)
582 828
Fax number
info@eliranga.lt
- LU Luxembourg**
Please contact
Weidmüller Benelux B. V.
Netherlands
- LV Latvia**
SIA Abi4
Daugavgrivas 31b
Rīga, LV-1007
Telephone number +371 674
70999
Fax number +371 676
24562
abi_4@tvnet.lv
- Representative Office
Weidmüller Interface GmbH
& Co. KG
Udens str. 12-118
Rīga, LV-1007
Telephone number +371
29254766
Fax number +371 674
65637
ilgonis.rudaks@weidmueller.com
www.weidmueller.com
- MA Morocco**
Sofimed
137, Bd Moulay Ismail Roches
Noires
20290 Casablanca
Telephone number
Fax number
contact@sofimedmaroc.com
- MD Moldova**
BERHORD A & D srl
79/1, str. Milescu Spartaru
MD-2075 Chisinau
Moldova
Telephone number +373 (22)
815002
Fax number +373 (22)
815007
atuleanu@berhord.com
www.ad.berhord.com
- ME Montenegro**
Please contact
our Representative Office
Weidmüller Interface GmbH
& Co. KG
Serbia.
- MG Madagascar**
Please contact
Phambili Interface
South Africa
- MK Macedonia**
Please contact
our Representative Office
Weidmüller Interface GmbH
& Co. KG
Serbia
- or
- ELEKTRO - SMK doool
UL. III Makedonska brigada
b.b.
1000 Skopje
Telephone number +389
22460295
Fax number
Elektro-smk@telelab.net.mk
- MN Mongolia**
Please contact
our Representative Office
Weidmüller Interface
Azerbaijan.
- MT Malta**
E. S. S., Electrical Supplies &
Services Ltd.
San Gwakklin Road
Mriehel
- Telephone number +356
21255777
Fax number +356 21255999
robert.agius@ess.com.mt
- MU Mauritius**
Mubelo Electrical Ltd.
Office 26, Gateway building,
St Jean Road
Quatre Bornes
Mauritius
Telephone number +230
4670989
Fax number +230 4654051
richard.mubelo@orange.mu
- MW Malawi**
Please contact
our Representative Office
Weidmüller Interface GmbH
& Co. KG
South Africa.
- MX Mexico**
W Interconnections S. A.
DE C. V.
Blvd. Hermanos Serdán 698,
Col. San Rafael Oriente
72029 Puebla
Telephone number +52 (222)
268 6227
Fax number +52 (222) 286
6242
clientes@weidmueller.com.mx
- MY Malaysia**
Connect Plus Technology
Sdn Bhd
No. 43, Jalan PJS 11/22,
Bandar Sunway
46150 Petaling Jaya
Selangor Darul Ehsan
Telephone number +60 3
5633 7363
Fax number +60 3 5633
6562
paul@cpctech.com.my
www.cpctech.com.my
- MZ Mozambique**
Please contact
Phambili Interface
South Africa
- NA Namibia**
Please contact
Phambili Interface
South Africa
- NG Nigeria**
Please contact
Weidmüller Interface GmbH
& Co. KG
South Africa
- NL Netherlands**
Weidmüller Benelux B. V.
Franciscusweg 221
1216 SE Hilversum
P.O. Box 1505
1200 BM Hilversum
Telephone number +31 35
626 12 61
Fax number +31 35 623
20 44
info@weidmueller.nl
www.weidmueller.nl
- NO Norway**
Sivilingeniør J.F. Knudtzen AS
Billingstadsletta 97
1396 Billingstad
PO Box 160
1378 Nesbru
Telephone number +47 66
98 33 50
Fax number +47 66 98 09 55
firmapost@jfknudtzen.no
www.jfknudtzen.no
- NZ New Zealand**
Cuthbert S. Stewart Ltd.
27 Te Puni Street
Petone
PO Box 38496
Wellington Mail Centre 5054
Telephone number (04) 568
6156
Fax number (09) 489 1752
csi@cuthbertstewart.co.nz
- Cuthbert S. Stewart Ltd
4 Fred Thomas Drive
Aon Building, Ground Floor,
South Entry
Takapuna
PO Box 100 338
North Shore City 745
Telephone number (09) 489
1751
Fax number (04) 568 6056
cslak@cuthbertstewart.co.nz
- OM Oman**
DAN INTERNATIONAL LLC.
Ghala St. 111
BP 2901
Seeb
Telephone number +968
5036 77
Fax number +968 5037 55
yedu@danint.com
- PE Peru**
IMPEXINCA S.A.C.
Calle Ortiz de Zavallos No.
105, Urb. San Antonio
18
Lima, Miraflores
Telephone number +51 1
447 5608
info@impexinca.pe
www.impexinca.pe
- J & W CIA, S. A.
Calle 6 Mz. D Lte. 23, Urb.
Ind. Grimanesa
01
Callao
Telephone number +51 1
572 2539
Fax number +51 1 572 0152
contacto@jwcia.com
www.jwcia.com
- PH Philippines**
Enclosure Systems Specialists
Inc.
2276 Don Chino Roces
Avenue Extension
Room 103/105 Narra Building
1231 Makati City
Telephone number +63 2
813 8580
Fax number +63 2 813 8596
sales_encsys@pltdtdsl.net
www.enclosuresystemsph.com
- PK Pakistan**
Automation Controls (Pak)
Apartment No. 33 C III,
Chenab Block, Allama Iqbal
Town
Lahore
Telephone number +92 42
37809948
Fax number +92 42
37809950
nadeem@acpak.com.pk
www.acpak.com.pk
- PL Poland**
Weidmüller Sp. z o. o.
ul. Ogrodowa 58
00-876 Warszawa
Telephone number +48 22
510 09 40
Fax number +48 22 510
09 41
biuro@weidmueller.com.pl
www.weidmueller.pl
- PR Puerto Rico**
Please contact
W Interconnections Inc.
United States
- PT Portugal**
Weidmüller Sistemas de
Interface S. A.
Estrada Outeiro Polima, R.
Augusto Dias da Silva, Lote
B - Esc. 2
São Domingos de Rana
2785-515 Abóboda
Telephone number +351 214
459 191
Fax number +351 214
455 871
weidmuller@weidmueller.pt
www.weidmueller.pt
- Telephone number +974
4651441
Fax number +974 4654579
dmtctech@qatar.net.qa
http://www.dohamotorsgroup.com/td.html
- Petroleum Technology Co.
W.L.L.
PO Box 16069
5th Floor Toyota tower
Telephone number +974
44419603
Fax number +974 44419604
petrotec@qatar.net.qa
www.petrotec.com.qa
- PY Paraguay**
Please contact
CPI SA
Argentina
- QA Qatar**
Doha Motors
PO Box 145
- Telephone number +974
4651441
Fax number +974 4654579
dmtctech@qatar.net.qa
http://www.dohamotorsgroup.com/td.html
- Petroleum Technology Co.
W.L.L.
PO Box 16069
5th Floor Toyota tower
Telephone number +974
44419603
Fax number +974 44419604
petrotec@qatar.net.qa
www.petrotec.com.qa
- RO Romania**
Representative Office
Weidmüller Interface GmbH
& Co. KG
Ionescu Crum Street, No.
1, 1st Tower, 1st Floor,
Office 4
500446 Brasov - Brasov
Business Park
Telephone number +40 (268)
446 222
Fax number +40 (262)
205 410
claudiu.totea@weidmueller.com
www.weidmueller.com
- RS Serbia**
Representative Office
Weidmüller Interface GmbH
& Co. KG
Ustanička 189, III sprat
lokal 7a
11050 Beograd
Telephone number +381
112885274
Fax number +381
112885274
zoran.rabrenovic@weidmueller.com
- TeLa Elektrik d.o.o.
Ul. Dr. Drage Ljočić 6
Beograd
Telephone number +381 11
2772 415
Fax number +381 11 2772
850
office@tela.rs
www.tela.rs
- RU Russia**
Weidmüller Group
7/10 Khlebozavodskiy
Passage,
Moskau
115230
Telephone number +7 495
280 72 71
Fax number +7 495 280
72 71
Info@weidmueller.ru
www.weidmueller.ru
- SA Saudi Arabia**
Al Abdulkarim Holding Co.
P.O. Box 4
Dammam 31411
Telephone number +966 3
8337110
Fax number +966 3
8829547
E-mail salehsk@akh.com.sa
www.weidmueller.ae
- Saudi Electric Supply
Company (SESCO)
P.O. Box 32 98
Al Khobar 31952
Telephone number +966 3
8829546 Ext. 3030
Fax number
E-mail Safdar.Malik@sescogex.com
www.sescogex.com
- SE Sweden**
Weidmüller AB
Axel Danielssons väg 271
BOX 31025
SE-200 49 Malmö
Telephone number +46 77-
143 00 44
Fax number +46 40-37 48 60
info@weidmueller.se
www.weidmueller.se
- SG Singapore**
Weidmüller Pte. Ltd.
70 Bendemeer Road
04-03 Luzerne Building
Singapore 339940
Telephone number +65 6841
5311
Fax number +65 6841 5377
info@weidmueller.com.sg
www.weidmueller.com.sg
- SI Slovenia**
Elektrospoji d. o. o.
Stegne 27
SI- 1000 Ljubljana
Osrednjeslovenska
Telephone number +386 1
511 3810
Fax number +386 1 511
1604
info@elektrospoji.si
www.elektrospoji.si
- SK Slovakia**
ELEKTRIS s.r.o.
Elektrárnská 1
831 04 Bratislava
Telephone number +421
2/4920 0113
Fax number +421 2/4920
0119
bratislava@elektris.sk

Addresses worldwide

Let's connect.

- SV El Salvador**
Prestegard Electro
11 Avenida Norte No. 240
Edificio Salazar No. 2
San Salvador
Telephone number +503
2271 1690
Fax number +503 2221
3851
prestegard@navegante.com.sv
- SY Syria**
Please contact
Weidmüller Middle East FZE
United Arab Emirates
- SZ Swaziland**
Please contact
Phambili Interface
South Africa
- TH Thailand**
Pisanu Engineering Co. Ltd.
Kwang Dingaeng, Khet
Dingaeng
800/2 Soi Trakulsuk, Asoke-
dindaeng Road
Dindaeng, Bangkok
10400
Telephone number +66 2
248 2896
Fax number +662 105 6301
ecsales@pisanu.co.th
www.pisanu.co.th

Representative Office
Weidmüller Pte. Ltd.
37/F, Sathorn Square Building
98 North Sathorn Road
Bangkok, Silom Bangrak
10500
Telephone number +66 2
105 6300
Fax number +66 2 642 9220
info@weidmuller.com.sg
- TJ Tajikistan**
Please contact
our Representative Office
Weidmüller Interface
Azerbaijan.
- TM Turkmenistan**
Please contact
our Representative Office
Weidmüller Interface
Azerbaijan.
- TN Tunisia**
Please contact
Weidmüller E. U. R. L.
France
- TR Turkey**
Weidmüller Elektronik Ticaret
Ltd. Sirketi
Kavacik Mah. Orhan Veli Kanik
Caddesi 9/1
34810 Beykoz / Istanbul
Telephone number +90 (216)
537 10 70
Fax number +90 (216) 537
10 77
info@weidmuller.com.tr
www.weidmuller.com.tr
- TW Taiwan**
Weidmüller (Hong Kong)
Limited
No. 3, Lane 89, ChungYang
N. Rd
24148 SanChuang City,
Taipei
Telephone number +886 921
949 751
roy.lin@weidmueller.com.hk
- TZ Tanzania**
Please contact
our Representative Office
Weidmüller Interface GmbH
& Co. KG
South Africa.
- UA Ukraine**
LLC WM UKRAINE
Levanevskogo str. 6
Kiev
3058
Telephone number +38 044
490 32 48
Fax number
info@wm-ua.com.ua
wm-ua.com.ua/

Representative Office
Weidmüller Interface GmbH
& Co. KG
Z, office 303
7-D, Zdolbunivska str.
Kiev, 2081
Telephone number
(mobile) +38 050 440 25 24
info.ua@weidmueller.com
- US United States**
W Interconnections Inc.
821 Southlake Boulevard
Richmond Virginia 23236
Telephone number +1 (804)
794-2877
Fax number +1 (804) 379-
2593
info@weidmuller.com
www.weidmuller.com
- UY Uruguay**
REWUO Uruguay S. A.
AV. Bolivia 2001Esq
Rocafuerte
11300 Carrasco Montevideo
Telephone number +598
2604 8439
Fax number +598 2604
8439
rewo@rewouruguay.com.uy
- UZ Republic of Uzbekistan**
Please contact
our Representative Office
Weidmüller Interface
Azerbaijan.
- VE Venezuela**
Somerinca C. A.
Corazon de Jesus - 3ra
Transversal con calle el
Carmen- Los Dos Caminos
Caracas 1070-A
Telephone number +58
2 122352748
Fax number +58
2 122399341
klocmoeller@cantv.net
www.somerinca.com
- VN Vietnam**
ALUMI Industrial Equipment &
Automation Company Limited
E1, La Thanh Hotel
218 Doi Can Street
Lieu Giai Ward, Ba Dinh
District
Hanoi City
Telephone number +84 4
37628601
Fax number +84 4
62661391
aumi@aumi.com.vn
www.aumi.com.vn

Representative Office
Weidmüller Pte. Ltd.
Level 16 Saigon Tower
Building
29 Le Duan Street
District 1
Ho Chi Minh
Telephone number +848
3520 7717
Fax number +848 3520
7604
info@weidmuller.com.sg
- ZA South Africa**
Phambili Interface
PO Box 193
1609 Johannesburg, Edenvale
5 Bundo Road, Sebenza
1610 Johannesburg
Telephone number +27 (11)
4521930
Fax number
info@weidmuller.co.za
www.weidmuller.co.za

Representative Office
Weidmüller Interface GmbH
& Co. KG
210 Amarand
Avenue, Pegasus Building
181 Pretoria, waterkloof Glen
ext 2 -
Telephone number +27 12
003 2906
Fax number +27 (11)
4526455
Jacques.Vosloo@weidmueller.
com
www.weidmueller.com
- ZM Zambia**
Please contact
Phambili Interface
South Africa
- ZW Zimbabwe**
Please contact
Phambili Interface
South Africa