

Printview: Male connector; with straight solder pins; 2-pole; pin spacing 5 mm / 0.197 in; 100% protected against mismatching; without preceding ground contact; with closed end; Vertical PCB mounting - Item No.: 721-132/001-000

WAGO® online catalog / eShop

Male connector; with straight solder pins; 2-pole; pin spacing 5 mm / 0.197 in; 100% protected against mismatching; without preceding ground contact; with closed end; Vertical PCB mounting

Item No.: 721-132/001-000



Male connector; with straight solder pins; 2-pole; pin spacing 5 mm / 0.197 in; 100% protected against mismatching; without preceding ground contact; with closed end; Vertical PCB mounting

Marking

RoHS ✓
Compliant

Business data

Supplier	WAGO
Item no.	721-132/001-000
GTIN / EAN	4044918868808
Content	1
Order amount	200
Customer item number	

Notes

Version with press-in pins provides solder-free connection to PCB 100% protected against mismatching Coding option available

Technical data

Miscellaneous

No. of poles	2
Pin Spacing	5 mm / 0.197 in %
Color	light gray
Ratings according to 1	IEC/EN 60664-1
Overvoltage category EN 1	III
Pollution degree (1)	2

Printview: Male connector; with straight solder pins; 2-pole; pin spacing 5 mm / 0.197 in; 100% protected against mismatching; without preceding ground contact; with closed end; Vertical PCB mounting - Item No.: 721-132/001-000

Technical data	
<i>Rated voltage EN (1) [V]</i>	320 [V]
<i>Rated surge voltage (1) [kV]</i>	4 [kV]
<i>Nominal current [A]</i>	12 [A]
<i>Overvoltage category EN 2</i>	II
<i>Degree of pollution (2)</i>	2
<i>Rated voltage EN (2) [V]</i>	630 [V]
<i>Rated surge voltage (2) [kV]</i>	4 [kV]
<i>Nominal current (2) [A]</i>	12 [A]
<i>Overvoltage category EN 3</i>	III
<i>Degree of pollution (3)</i>	3
<i>Rated voltage EN (3) [V]</i>	320 [V]
<i>Rated surge voltage (3) [kV]</i>	4 [kV]
<i>Nominal current (3) [A]</i>	12 [A]
<i>Solder pin length [mm]</i>	5 [mm]
<i>Solder pin width A [mm]</i>	1 [mm]
<i>Solder pin width B [mm]</i>	1 [mm]
<i>Tolerance of drilled hole [mm]</i>	1.4(+ 0.1) [mm]
<i>Material group</i>	I
<i>Insulating material</i>	Polyamide 66 (PA 66)
<i>Flammability rating per UL 94</i>	V0
<i>Limit temperature range</i>	-60 C ... 100 C
<i>Contact material</i>	Electrolytic copper (Ecu)
<i>Contact plating</i>	tin-plated
<i>Fire load [MJ]</i>	0.018 [MJ]
<i>Weight [g]</i>	0.884 [g]
<i>Width</i>	13.2 mm / 0.52 in
<i>Height</i>	17 mm / 0.669 in
<i>Height from the surface</i>	12 mm / 0.472 in
<i>Length</i>	11.4 mm / 0.449 in

Printview: Male connector; with straight solder pins; 2-pole; pin spacing 5 mm / 0.197 in; 100% protected against mismatching; without preceding ground contact; with closed end; Vertical PCB mounting - Item No.: 721-132/001-000

Images & drawings

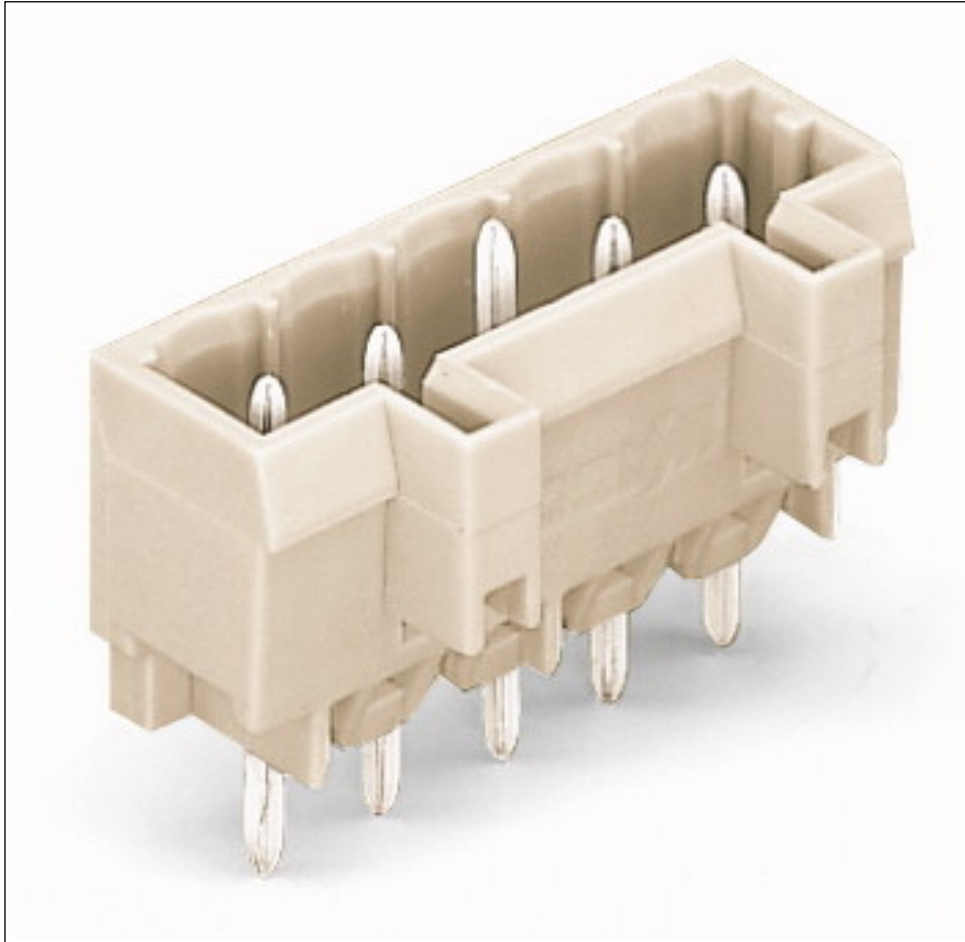

Printview: Male connector; with straight solder pins; 2-pole; pin spacing 5 mm / 0.197 in; 100% protected against mismatching; without preceding ground contact; with closed end; Vertical PCB mounting - Item No.: 721-132/001-000

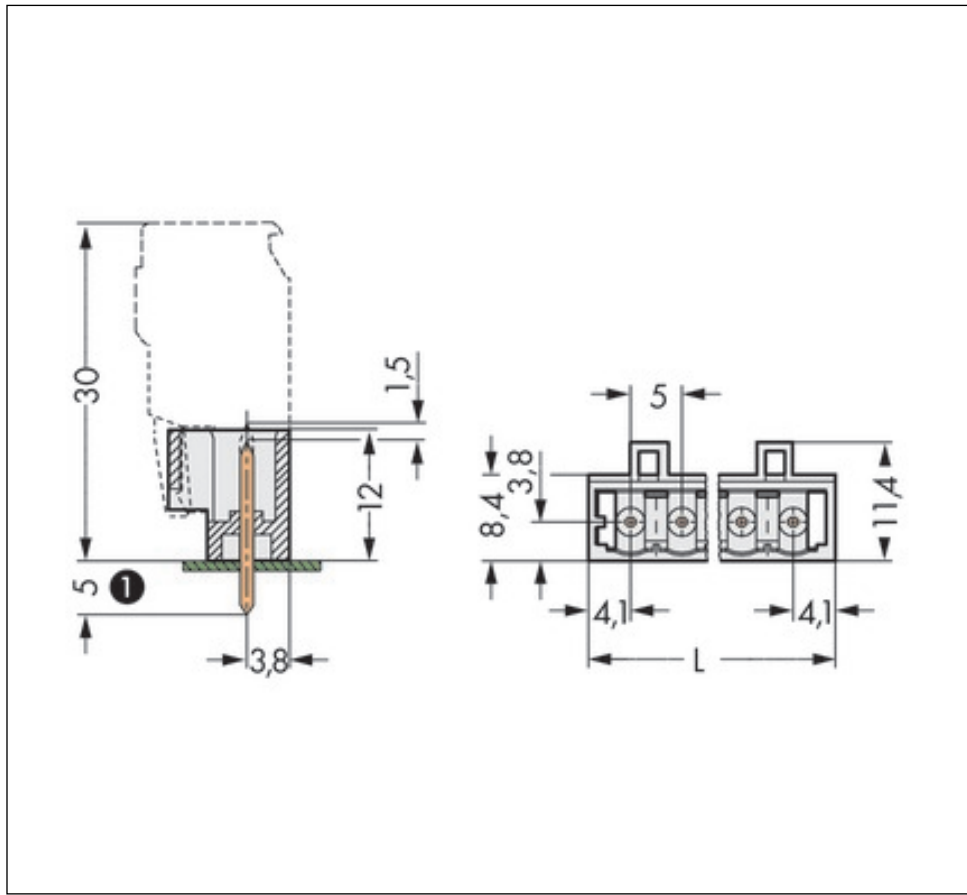

Address

WAGO Kontakttechnik GmbH & Co. KG

Hansastr. 27

32423 Minden

Telefon: 0571/887-0

Fax: 0571/887-169

<http://www.wago.com>

© WAGO Kontakttechnik GmbH & Co. KG

Technische Änderungen und Irrtümer vorbehalten.