



## Product Compliance

[For compliance documentation, visit the product page on TE.com>](#)

EU RoHS Directive 2011/65/EU	Compliant
EU ELV Directive 2000/53/EC	Compliant
China RoHS 2 Directive MIIT Order No 32, 2016	有害物质含量符合标准要求 No Restricted Substance(s) Above Threshold
EU REACH Regulation (EC) No. 1907/2006	Current ECHA Candidate List: JUNE 2025 (250) Candidate List Declared Against: JUNE 2025 (250) Does not contain REACH SVHC
Halogen Content	Low Halogen - Br, Cl, F < 900 ppm per homogenous material. Also BFR/CFR/PVC Free
Solder Process Capability	Not reviewed for solder process capability

### Product Compliance Disclaimer

This information is provided based on reasonable inquiry of our suppliers and represents our current actual knowledge based on the information they provided. This information is subject to change. The part numbers that TE has identified as EU RoHS compliant have a maximum concentration of 0.1% by weight in homogenous materials for lead, hexavalent chromium, mercury, PBB, PBDE, DBP, BBP, DEHP, DIBP, and 0.01% for cadmium, or qualify for an exemption to these limits as defined in the Annexes of Directive 2011/65/EU (RoHS2). Finished electrical and electronic equipment products will be CE marked as required by Directive 2011/65/EU. Components may not be CE marked. Additionally, the part numbers that TE has identified as EU ELV compliant have a maximum concentration of 0.1% by weight in homogenous materials for lead, hexavalent chromium, and mercury, and 0.01% for cadmium, or qualify for an exemption to these limits as defined in the Annexes of Directive 2000/53/EC (ELV). Regarding the REACH Regulation, the information TE provides on SVHC in articles for this part number is based on the latest European Chemicals Agency (ECHA) 'Guidance on requirements for substances in articles' posted at this URL: <https://echa.europa.eu/guidance-documents/guidance-on-reach>

## Compatible Parts

TE Part # 1SNA168511R2000  
[BRE-T-SPEC](#)

TE Part # 1SNA118972R2400  
[DIP](#)

TE Part # 1SNA173527R1500  
[BRJV3](#)

TE Part # 1SNA167610R0600  
[BRJ2AG](#)

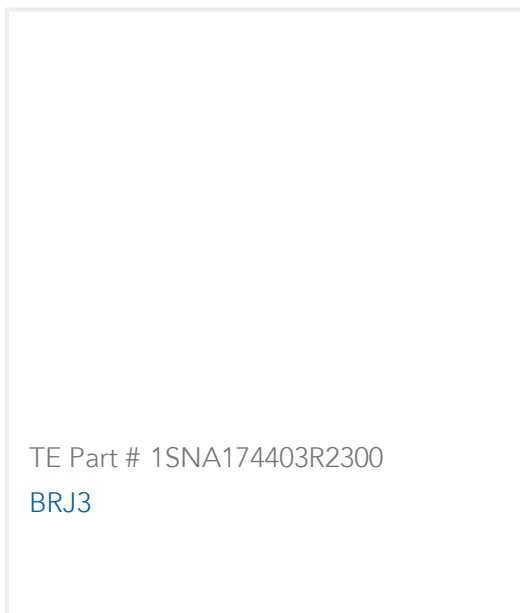

TE Part # 1SNA174403R2300  
BRJ3

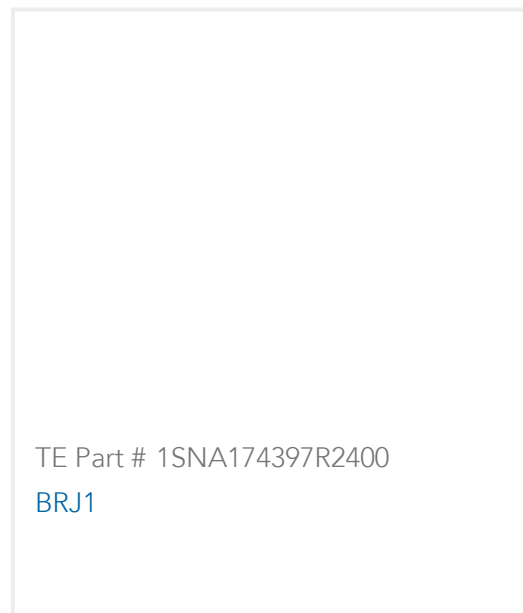

TE Part # 1SNA174397R2400  
BRJ1

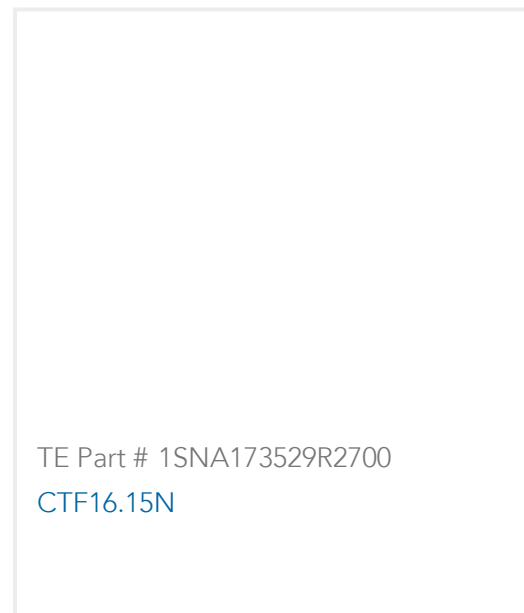

TE Part # 1SNA173529R2700  
CTF16.15N

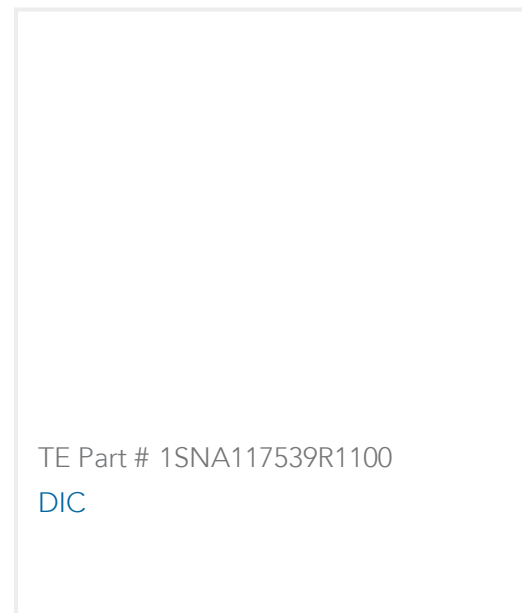

TE Part # 1SNA117539R1100  
DIC

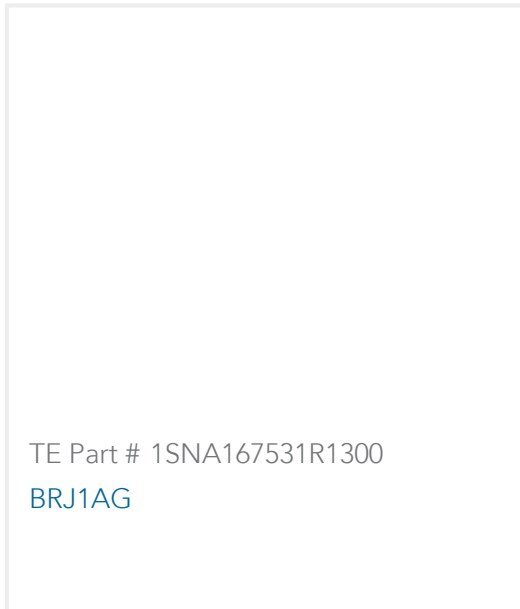

TE Part # 1SNA167531R1300  
BRJ1AG

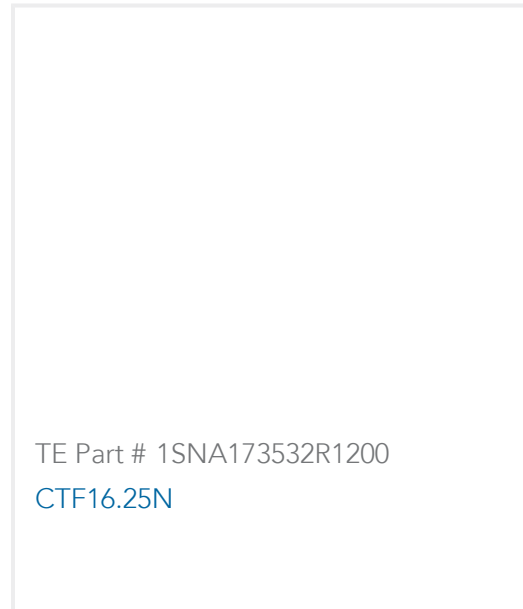

TE Part # 1SNA173532R1200  
CTF16.25N

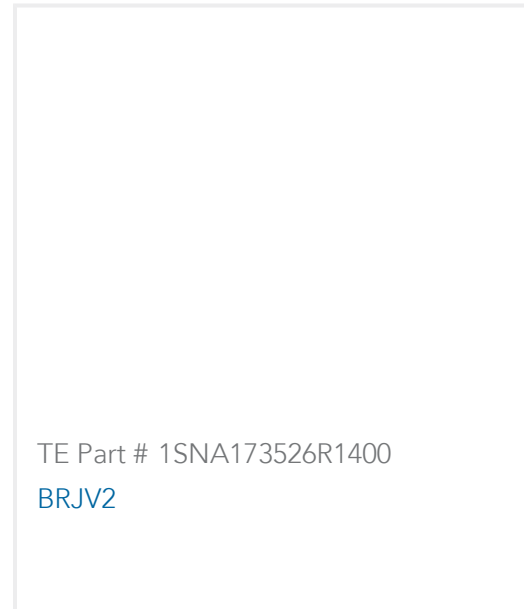

TE Part # 1SNA173526R1400  
BRJV2

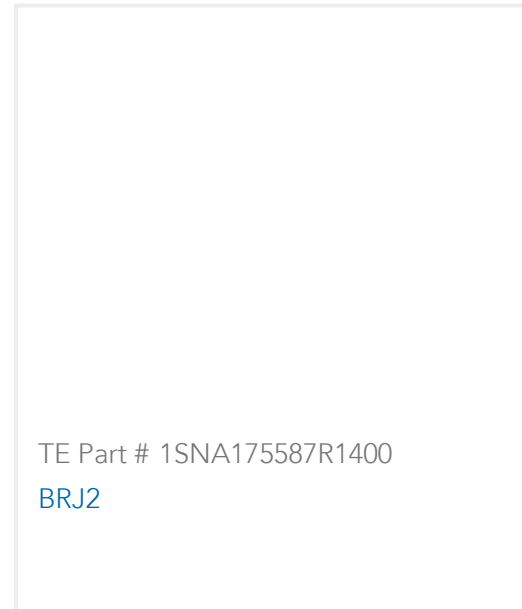

TE Part # 1SNA175587R1400  
BRJ2



TE Part # 1SNA173525R1300  
BRJV1

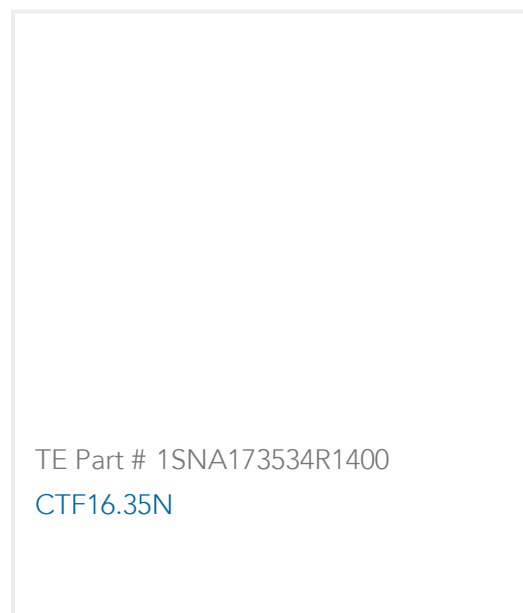

TE Part # 1SNA173534R1400  
CTF16.35N

### Customers Also Bought



TE Part #CAT-D48-ST273  
DEUTSCH Connector Solid Contacts



TE Part #DT04-2P  
REC, 2P, GRY, N



TE Part #CAT-D487-W416  
Wedgelocks: DEUTSCH DT



TE Part #DT06-2S  
PLG, 2P, GRY, N



TE Part #114017-ZZ  
SEALING PLUG, SIZE 12/16, WHT

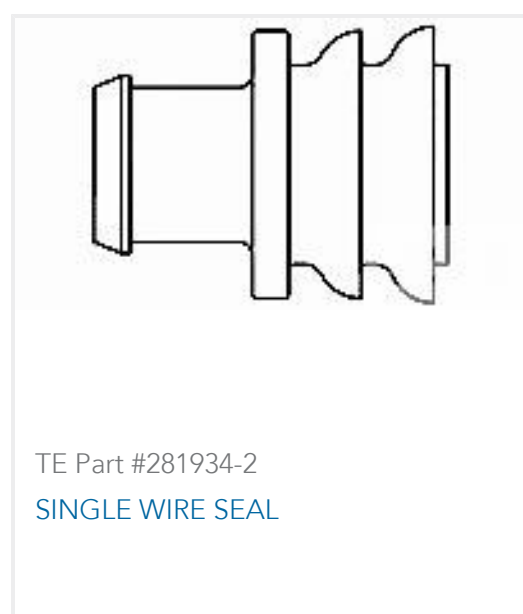

TE Part #281934-2  
SINGLE WIRE SEAL

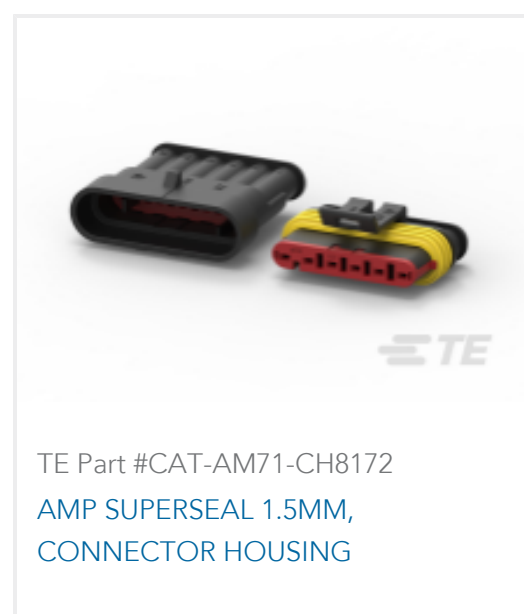

TE Part #CAT-AM71-CH8172  
AMP SUPERSEAL 1.5MM,  
CONNECTOR HOUSING

### Documents



Datasheets & Catalog Pages

EXBR

English