

Multilayer Ceramic Chip Capacitor

Part Number: 1210Y5000104KST

Description: 1210 500Vdc 100nF ±10% X7R (2R1) to AEC-Q200 (CTI ≥ 600)

A range of X7R MLC capacitors fully tested and approved to automotive specification AEC-Q200. Available in a wide selection of chip sizes, working voltages and termination options, including FlexiCap™, the world's first commercially available flexible termination.

DR1, WR2 and WR3 parts have a voltage de-rating above 105°C.

WS2, WS3, WR2 and WR3 parts use StackiCap™ patented construction technology.

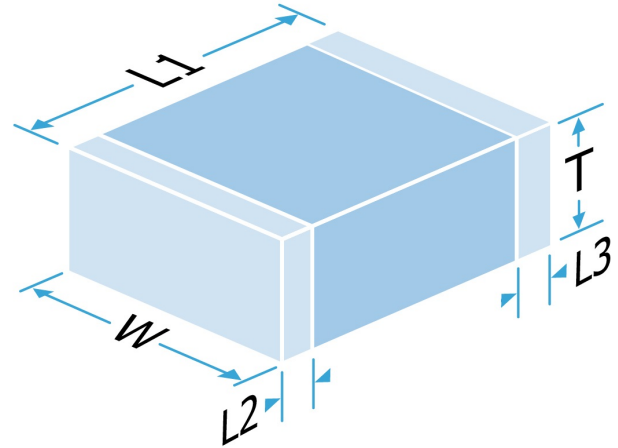

Mechanical Specification

Size Code	1210
Length (L1) in mm (")	3.2 +0.30/-0.20 (0.126 +0.012/-0.008)
Width (W) in mm (")	2.5 ± 0.20 (0.098 ± 0.008)
Thickness (T) in mm (")	2.0 Max (0.08 Max)
Minimum Termination Band (L2,L3) in mm (")	0.25 (0.010)
Maximum Termination Band (L2,L3) in mm (")	0.75 (0.030)
Termination Material	FlexiCap™ Polymer termination, Nickel barrier, Sn Plated Solder (RoHS compliant)
Solderability	IEC-60068-2-58
Packaging	7" Reel Horizontal Orientation, 2000 per reel
Conformal Coating	Not normally required

General Electrical Specification

Rated Voltage	500Vdc
Nominal Capacitance Value	100nF
Capacitance Tolerance	±10%
Tangent of Loss Angle (Tan δ)	≤0.025
Capacitance and Tan δ Test Conditions	1.0Vrms @ 1kHz
Voltage Proof	750Vdc
(Voltage applied for 5 secs max. @ 50mA max. charge current. 50% Max, RH)	
Min Insulation Resistance (IR)	10.00GOhm @ 100Vdc
Dielectric Classification	X7R (2R1) to AEC-Q200 (CTI ≥ 600)
Rated Temperature Range	-55°C / +125°C
Maximum Capacitance Change over Temperature Range	No DC Voltage ±15%
Climatic Category (IEC)	Rated DC Voltage -
Ageing Characteristic	55/125/56
	<2% per decade (nominal capacitance is 1000 hour value)

Knowles Precision Devices - Sales

Europe: KPD-Europe-sales@knowles.com

Asia: KPD-Asia-sales@knowles.com

USA: KPD-NA-sales@knowles.com

www.knowlescapacitors.com

This datasheet is for a standard item and is confirmed valid on the date generated, the latest published data for this part may differ and is available at <http://www.knowlescapacitors.com> or by contacting us.

© The information contained on this drawing is confidential and may not be copied in whole or part in any form or disclosed to a third party without the consent of Knowles and any customer mentioned within this specification.

Data is correct to the best of our knowledge, errors and omissions excepted.

Date: Monday, January 12, 2026

20260112 094526097UTC

Multilayer Ceramic Chip Capacitor

Part Number: 1210Y5000104KST

Description: 1210 500Vdc 100nF ±10% X7R (2R1) to AEC-Q200 (CTI ≥ 600)

Environmental

RoHS Compliant to 2011/65/EC as amended by 2015/863/EU	Compliant
REACH Compliant	250 compliant
California Proposition 65	No exposure risk

Board Layout

Knowles' conventional 2-terminal chip capacitors can generally be mounted using pad designs in accordance with international specification IPC-7351, Generic Requirements for Surface Mount Design and Land Pattern Standards, but there are some other factors that have been shown to reduce mechanical stress, such as reducing the pad width to less than the chip width. In addition, the position of the chip on the board should be considered.

IPC-7351 pad design

	1210	
C	3.00mm	0.118"
Y	1.15mm	0.045"
X	2.70mm	0.106"

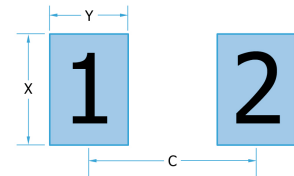

Some high voltage parts may require modifications to the board layout and/or the addition of a conformal coating to prevent flashover, especially under high humidity conditions. Board cleanliness and environmental conditions can also impact this. Refer to application note AN0043 for further information.

Packaging

Tape packaging information for tape-and-reel parts:

Tape and reel packing of surface mounting chip capacitors for automatic placement are in accordance with IEC60286-3.

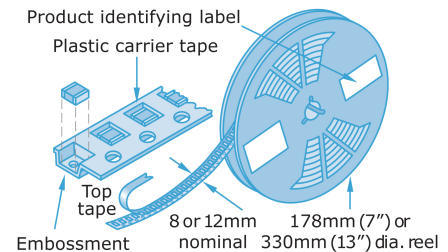

Soldering

Reflow solder in accordance with IPC-A-610. Recommended reflow profile as laid down in IPC/JEDEC J-STD-020.

Wave soldering is also possible, but care must be taken for case sizes 1210 and larger and component thickness >1.0mm. Trials are encouraged.

Hand soldering is not recommended and can lead to component damage through thermal shock.

PdAg terminations are primarily intended for conductive epoxy attachment - they may be suitable for soldering but trials are recommended.

Application notes with mounting and handling guidance are available on request.

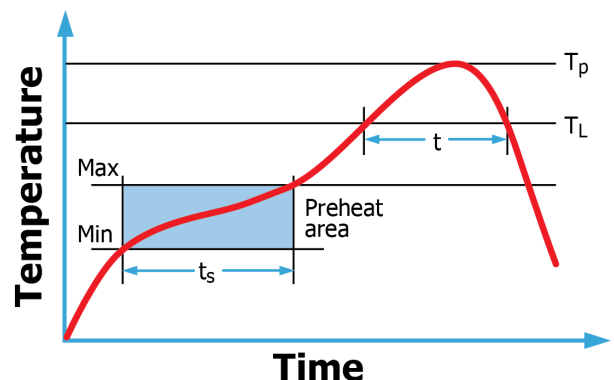

Compex

DLI

Johanson MFG

Novacap

Syfer

Voltronics

Knowles Precision Devices - Sales

Europe: KPD-Europe-sales@knowles.com

Asia: KPD-Asia-sales@knowles.com

USA: KPD-NA-sales@knowles.com

www.knowlescapacitors.com

This datasheet is for a standard item and is confirmed valid on the date generated, the latest published data for this part may differ and is available at <http://www.knowlescapacitors.com> or by contacting us.

© The information contained on this drawing is confidential and may not be copied in whole or part in any form or disclosed to a third party without the consent of Knowles and any customer mentioned within this specification.

Data is correct to the best of our knowledge, errors and omissions excepted.

Date: Monday, January 12, 2026

20260112 09452609/UTC

Part Number: 1210Y5000104KST

Description: 1210 500Vdc 100nF ±10% X7R (2R1) to AEC-Q200 (CTI ≥ 600)

DC Bias Characteristics

VCC Characterization

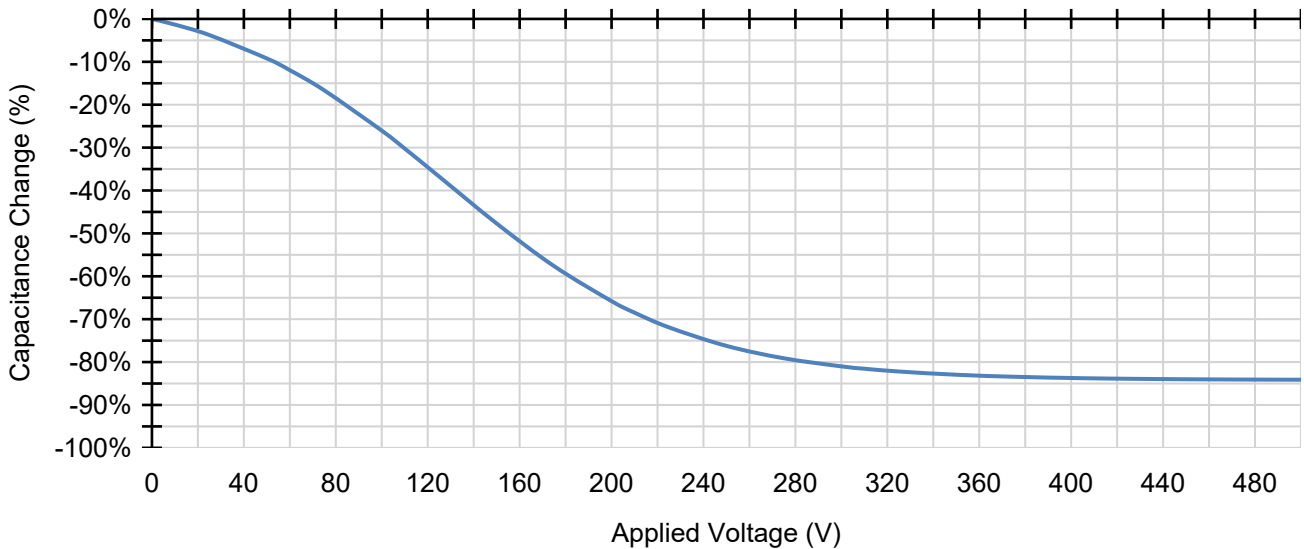

% Capacitance Drift with Time

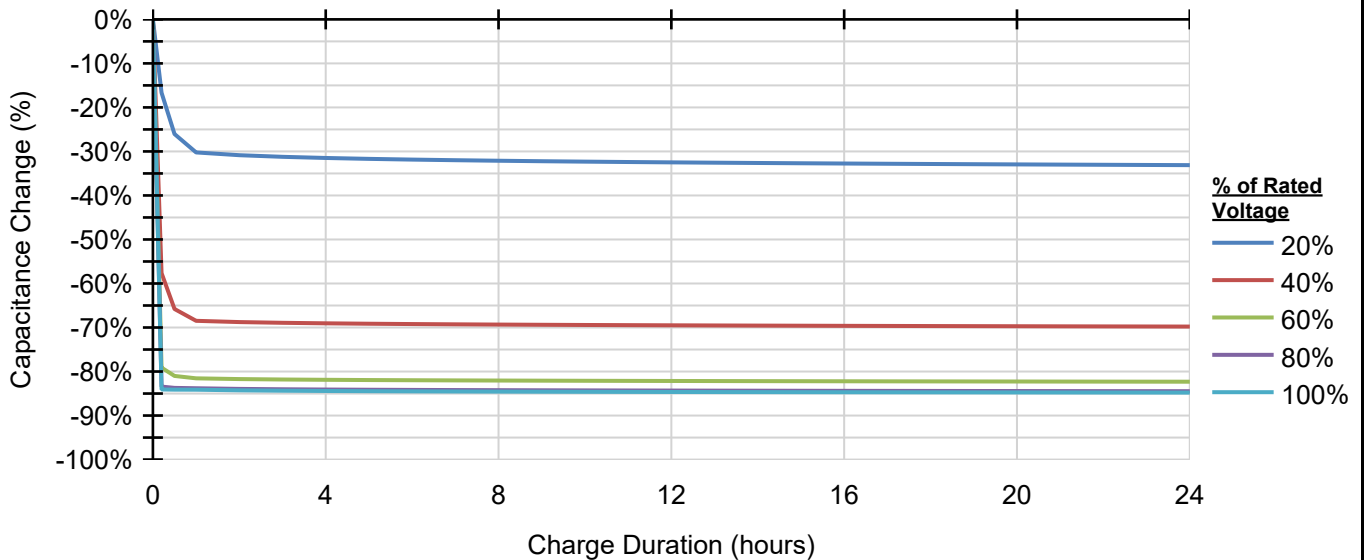

The curves represent the 'typical worst case' curve – i.e. the typical curve of a 'worst case' component having the most capacitance loss delivered against the specification.

Knowles Precision Devices reserve the right to substitute any component with a similar component of the same or higher specification. In some cases this may mean that the capacitance drop with applied voltage is, in practice, less than the curve shown

Compex

DLI

Johanson MFG

Novacap

Syfer

Voltronics

Knowles Precision Devices - Sales

Europe: KPD-Europe-sales@knowles.com

Asia: KPD-Asia-sales@knowles.com

USA: KPD-NA-sales@knowles.com

www.knowlescapacitors.com

This datasheet is for a standard item and is confirmed valid on the date generated, the latest published data for this part may differ and is available at <http://www.knowlescapacitors.com> or by contacting us.

© The information contained on this drawing is confidential and may not be copied in whole or part in any form or disclosed to a third party without the consent of Knowles and any customer mentioned within this specification.

Data is correct to the best of our knowledge, errors and omissions excepted.

Date: Monday, January 12, 2026

20260112 094526097UTC

Part Number: 1210Y5000104KST

Description: 1210 500Vdc 100nF ±10% X7R (2R1) to AEC-Q200 (CTI ≥ 600)

Typical Capacitance Change vs Temperature

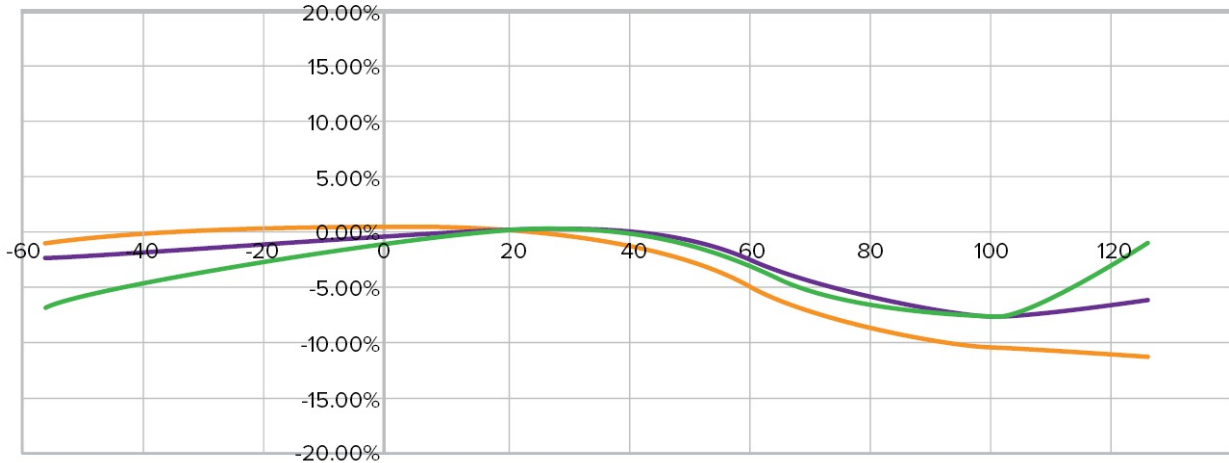

Typical TC Curves for X7R capacitors showing different dielectric types

Stable X7R Dielectric

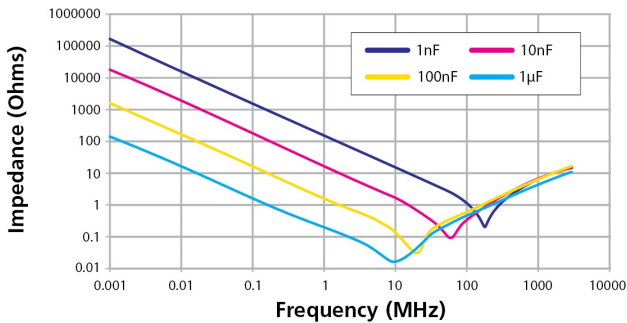

Stable X7R Dielectric

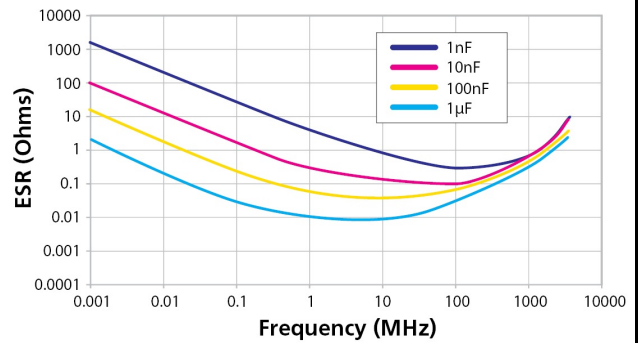

Stable X7R Dielectric — 10nF



Typical Performance Data - X7R

For part specific data, please contact your local sales office
This data is for reference only and does not constitute a specification.

Compex

DLI

Johanson MFG

Novacap

Syfer

Voltronics

Knowles Precision Devices - Sales

Europe: KPD-Europe-sales@knowles.com

Asia: KPD-Asia-sales@knowles.com

USA: KPD-NA-sales@knowles.com

www.knowlescapacitors.com

This datasheet is for a standard item and is confirmed valid on the date generated, the latest published data for this part may differ and is available at <http://www.knowlescapacitors.com> or by contacting us.

© The information contained on this drawing is confidential and may not be copied in whole or part in any form or disclosed to a third party without the consent of Knowles and any customer mentioned within this specification.

Data is correct to the best of our knowledge, errors and omissions excepted.

Date: Monday, January 12, 2026

20260112 094526097UTC