

Printed-circuit board connector - FKC 2,5/ 4-ST - 1910377

Please be informed that the data shown in this PDF Document is generated from our Online Catalog. Please find the complete data in the user's documentation. Our General Terms of Use for Downloads are valid (<http://phoenixcontact.com/download>)

Plug component, nominal current: 12 A, rated voltage (III/2): 320 V, number of positions: 4, pitch: 5 mm, connection method: Push-in spring connection, color: green, contact surface: Tin

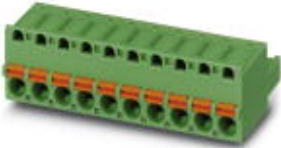

The figure shows a 10-position version of the product

Why buy this product

- ✓ Time saving push-in connection, tools not required
- ✓ Intuitive use through colour coded actuation lever
- ✓ Quick and convenient testing using integrated test option
- ✓ Can be combined with the MSTB 2,5 range

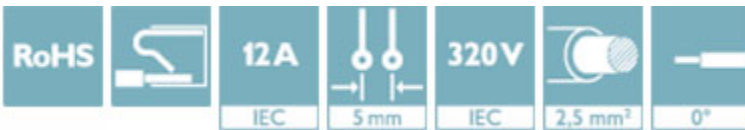

Key Commercial Data

Packing unit	1 STK
GTIN	 4 017918 175153
GTIN	4017918175153
Weight per Piece (excluding packing)	7.070 g
Custom tariff number	85366990
Country of origin	Germany

Technical data

Dimensions

Length [l]	25.4 mm
Width [w]	20.1 mm
Height [h]	15 mm
Pitch	5 mm
Dimension a	15 mm

Printed-circuit board connector - FKC 2,5/ 4-ST - 1910377

Technical data

General

Range of articles	FKC 2,5/..-ST
Type of contact	Female connector
Number of positions	4
Connection method	Push-in spring connection
Insulating material group	I
Rated surge voltage (III/3)	4 kV
Rated surge voltage (III/2)	4 kV
Rated surge voltage (II/2)	4 kV
Rated voltage (III/3)	250 V
Rated voltage (III/2)	320 V
Rated voltage (II/2)	630 V
Connection in acc. with standard	EN-VDE
Nominal current I_N	12 A
Nominal cross section	2.5 mm ²
Maximum load current	12 A
Insulating material	PA
Flammability rating according to UL 94	V0
Internal cylindrical gage	A2
Stripping length	10 mm

Connection data

Conductor cross section solid min.	0.2 mm ²
Conductor cross section solid max.	2.5 mm ²
Conductor cross section flexible min.	0.2 mm ²
Conductor cross section flexible max.	2.5 mm ²
Conductor cross section flexible, with ferrule without plastic sleeve min.	0.25 mm ²
Conductor cross section flexible, with ferrule without plastic sleeve max.	2.5 mm ²
Conductor cross section flexible, with ferrule with plastic sleeve min.	0.25 mm ²
Conductor cross section flexible, with ferrule with plastic sleeve max.	2.5 mm ²
Conductor cross section AWG min.	24
Conductor cross section AWG max.	12
2 conductors with same cross section, stranded, TWIN ferrules with plastic sleeve, min.	0.5 mm ²
2 conductors with same cross section, stranded, TWIN ferrules with plastic sleeve, max.	1.5 mm ²
Minimum AWG according to UL/CUL	26
Maximum AWG according to UL/CUL	12

Standards and Regulations

Printed-circuit board connector - FKC 2,5/ 4-ST - 1910377

Technical data

Standards and Regulations

Connection in acc. with standard	EN-VDE
	CSA
Flammability rating according to UL 94	V0

Environmental Product Compliance

China RoHS	Environmentally friendly use period: unlimited = EFUP-e
	No hazardous substances above threshold values

Drawings

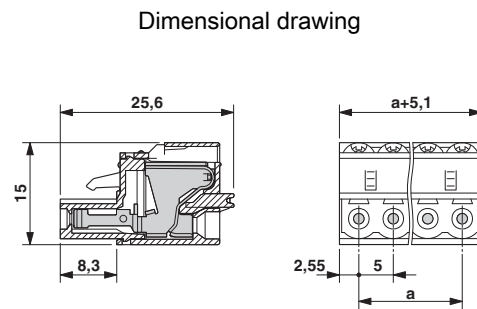
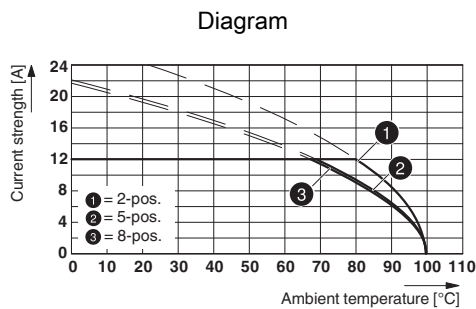

Type: FKC 2,5/...-ST with MSTB 2,5/...-G THT

Classifications

eCl@ss

eCl@ss 4.0	272607xx
eCl@ss 4.1	27260701
eCl@ss 5.0	27260701
eCl@ss 5.1	27260701
eCl@ss 6.0	27260704
eCl@ss 7.0	27440402
eCl@ss 8.0	27440309
eCl@ss 9.0	27440309

ETIM

ETIM 3.0	EC001121
ETIM 4.0	EC002638
ETIM 5.0	EC002638
ETIM 6.0	EC002638

Printed-circuit board connector - FKC 2,5/ 4-ST - 1910377

Classifications

UNSPSC

UNSPSC 6.01	30211810
UNSPSC 7.0901	39121409
UNSPSC 11	39121409
UNSPSC 12.01	39121409
UNSPSC 13.2	39121409

Approvals

Approvals

Approvals

CSA / VDE Gutachten mit Fertigungsüberwachung / cULus Recognized / EAC / IECCE CB Scheme

Ex Approvals

Approval details

CSA		http://www.csagroup.org/services-industries/product-listing/	13631
	B	D	
mm ² /AWG/kcmil	24-12	24-12	
Nominal current I _N	12 A	10 A	
Nominal voltage U _N	300 V	300 V	

VDE Gutachten mit Fertigungsüberwachung		http://www.vde.com/en/Institute/OnlineService/VDE-approved-products/Pages/Online-Search.aspx	40004701
mm ² /AWG/kcmil	0.2-2.5		
Nominal current I _N	12 A		
Nominal voltage U _N	250 V		

Printed-circuit board connector - FKC 2,5/ 4-ST - 1910377

Approvals

cULus Recognized		http://database.ul.com/cgi-bin/XYV/template/LISEXT/1FRAME/index.htm	E60425-19931011
	B	D	
mm ² /AWG/kcmil	26-12	26-12	
Nominal current I _N	10 A	10 A	
Nominal voltage U _N	300 V	300 V	

EAC		B.01742
-----	--	---------

IECEE CB Scheme		http://www.iecee.org/	DE1-56062-M1-B1B2
mm ² /AWG/kcmil	0.2-2.5		
Nominal current I _N	12 A		
Nominal voltage U _N	250 V		

Accessories

Accessories

Coding element

Coding profile - CP-MSTB - 1734634

Coding profile, is inserted into the slot on the plug or inverted header, red insulating material



Labeled terminal marker

Marker card - SK 5/3,8:FORTL.ZAHLEN - 0804183

Marker card, Card, white, labeled, Horizontal: Consecutive numbers 1 - 10, 11 - 20, etc. up to 91 - (99)100, mounting type: adhesive, for terminal block width: 5 mm, lettering field size: 5 x 3.8 mm



Printed-circuit board connector - FKC 2,5/ 4-ST - 1910377

Accessories

Screwdriver tools

Screwdriver - SZS 0,6X3,5 - 1205053



Actuation tool, for ST terminal blocks, insulated, also suitable for use as a bladed screwdriver, size: 0.6 x 3.5 x 100 mm, 2-component grip, with non-slip grip

Test plug terminal block

Test plugs - MPS-MT - 0201744



Test plugs, with solder connection up to 1 mm² conductor cross section, color: silver

Reducing plug - RPS - 0201647



Reducing plug, color: gray

Strain relief - STZ 4-FKC-5,08 - 1876877



Strain relief for snapping into the latching chambers of the plugs, 4-pos.

Strain relief - STZ 8-FKC-5,08 - 1876880

Strain relief for snapping into the latching chambers of the plug components, 8-pos.

Printed-circuit board connector - FKC 2,5/ 4-ST - 1910377

Accessories

Additional products

Base strip - MSTBW 2,5/ 4-G - 1736098

Header, nominal current: 12 A, rated voltage (III/2): 320 V, number of positions: 4, pitch: 5 mm, color: green, contact surface: Tin, mounting: Wave soldering



Base strip - MDSTB 2,5/ 4-G1 - 1736690

Header, nominal current: 10 A, rated voltage (III/2): 320 V, number of positions: 4, pitch: 5 mm, color: green, contact surface: Tin, mounting: Wave soldering, In combination with MVSTB or FKCV plug components, both an MVSTBW (or FKCVW) and an MVSTBR plug (or FKCVR) must be used. Combination with TMSTBP plug components is not possible!



Base strip - MDSTBV 2,5/ 4-G1 - 1736739

Header, nominal current: 10 A, rated voltage (III/2): 320 V, number of positions: 4, pitch: 5 mm, color: green, contact surface: Tin, mounting: Wave soldering, In combination with MVSTB or FKCV plug components, both an MVSTBV (or FKCVW) and an MVSTBR plug (or FKCVR) must be used. Combination with TMSTBP plug components is not possible!



Base strip - MSTBV 2,5/ 4-G - 1753479

Header, nominal current: 12 A, rated voltage (III/2): 320 V, number of positions: 4, pitch: 5 mm, color: green, contact surface: Tin, mounting: Wave soldering



Base strip - MSTB 2,5/ 4-G - 1754478

Header, nominal current: 12 A, rated voltage (III/2): 320 V, number of positions: 4, pitch: 5 mm, color: green, contact surface: Tin, mounting: Wave soldering



Printed-circuit board connector - FKC 2,5/ 4-ST - 1910377

Accessories

Printed-circuit board connector - MSTBVA 2,5/ 4-G - 1755532

Header, nominal current: 12 A, rated voltage (III/2): 320 V, number of positions: 4, pitch: 5 mm, color: green, contact surface: Tin, mounting: Wave soldering



Printed-circuit board connector - MSTBA 2,5/ 4-G - 1757491

Header, nominal current: 12 A, rated voltage (III/2): 320 V, number of positions: 4, pitch: 5 mm, color: green, contact surface: Tin, mounting: Wave soldering



Base strip - MSTB 2,5/ 4-G-LA - 1768202

Header, nominal current: 12 A, rated voltage (III/2): 320 V, number of positions: 4, pitch: 5 mm, color: green, contact surface: Tin, mounting: Wave soldering



Printed-circuit board connector - SMSTB 2,5/ 4-G - 1769256

Header, nominal current: 12 A, rated voltage (III/2): 320 V, number of positions: 4, pitch: 5 mm, color: green, contact surface: Tin, mounting: Wave soldering



Base strip - SMSTBA 2,5/ 4-G - 1769829

Header, nominal current: 12 A, rated voltage (III/2): 320 V, number of positions: 4, pitch: 5 mm, color: green, contact surface: Tin, mounting: Wave soldering



Printed-circuit board connector - FKC 2,5/ 4-ST - 1910377

Accessories

Base strip - MSTBA 2,5/ 4-G-LA - 1770504



Header, nominal current: 12 A, rated voltage (III/2): 320 V, number of positions: 4, pitch: 5 mm, color: green, contact surface: Tin, mounting: Wave soldering

Base strip - MDSTBVA 2,5/ 4-G - 1845808



Header, nominal current: 10 A, rated voltage (III/2): 320 V, number of positions: 4, pitch: 5 mm, color: green, contact surface: Tin, mounting: Wave soldering, The article can be aligned to create different nos. of positions! In combination with MVSTB or FKCV plug components, both an MVSTBW (or FKCVW) and an MVSTBR plug (or FKCVR) must be used. Combination with TMSTBP plug components is not possible!

Base strip - MDSTBV 2,5/ 4-G - 1845950



Header, nominal current: 10 A, rated voltage (III/2): 320 V, number of positions: 4, pitch: 5 mm, color: green, contact surface: Tin, mounting: Wave soldering, Can be aligned! Mounting flange: Order No. 1836477, 1836480. In combination with MVSTB or FKCV plug components, both an MVSTBW (or FKCVW) and an MVSTBR plug (or FKCVR) must be used. Combination with TMSTBP plug components is not possible!

Housing - MDSTB 2,5/ 4-G - 1846386



Header, nominal current: 10 A, rated voltage (III/2): 320 V, number of positions: 4, pitch: 5 mm, color: green, contact surface: Tin, mounting: Wave soldering, Can be aligned! Mounting flange: Order No. 1736771, 1736768. In combination with MVSTB or FKCV plug components, both an MVSTBW (or FKCVW) and an MVSTBR plug (or FKCVR) must be used. Combination with TMSTBP plug components is not possible!

Base strip - MDSTBA 2,5/ 4-G - 1846535

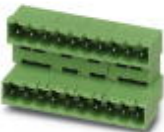

Header, nominal current: 10 A, rated voltage (III/2): 320 V, number of positions: 4, pitch: 5 mm, color: green, contact surface: Tin, mounting: Wave soldering, The article can be aligned to create different nos. of positions! In combination with MVSTB or FKCV plug components, both an MVSTBW (or FKCVW) and an MVSTBR plug (or FKCVR) must be used. Combination with TMSTBP plug components is not possible!

Printed-circuit board connector - FKC 2,5/ 4-ST - 1910377

Accessories

Base strip - MDSTBW 2,5/ 4-G - 1846836



Header, nominal current: 10 A, rated voltage (III/2): 320 V, number of positions: 4, pitch: 5 mm, color: green, contact surface: Tin, mounting: Wave soldering, The article can be aligned to create different nos. of positions! In combination with MVSTB or FKCV plug components, both an MVSTBW (or FKCVW) and an MVSTBR plug (or FKCVR) must be used. Combination with TMSTBP plug components is not possible!

Base strip - MSTBO 2,5/ 4-G1L - 1861060



Header, nominal current: 12 A, rated voltage (III/2): 320 V, number of positions: 4, pitch: 5 mm, color: green, contact surface: Tin, mounting: Soldering, Article with lateral pin exit

Base strip - MSTBO 2,5/ 4-G1R - 1861073



Header, nominal current: 12 A, rated voltage (III/2): 320 V, number of positions: 4, pitch: 5 mm, color: green, contact surface: Tin, mounting: Soldering, Article with lateral pin exit

Base strip - EMSTBA 2,5/ 4-G - 1899867



Header, nominal current: 12 A, rated voltage (III/2): 320 V, number of positions: 4, pitch: 5 mm, color: green, contact surface: Tin, mounting: Press-in technology

Base strip - EMSTBVA 2,5/ 4-G - 1914878



Header, nominal current: 12 A, rated voltage (III/2): 320 V, number of positions: 4, pitch: 5 mm, color: green, contact surface: Tin, mounting: Press-in technology

Printed-circuit board connector - FKC 2,5/ 4-ST - 1910377

Accessories

Base strip - MSTBA 2,5/ 4-G THT - 1927519



Header, nominal current: 12 A, rated voltage (III/2): 320 V, number of positions: 4, pitch: 5 mm, color: black, contact surface: Tin, mounting: THR soldering, User information and design recommendations for through hole reflow technology can be found under "Downloads"

Base strip - MSTBVA 2,5/ 4-G THT - 1941029



Header, nominal current: 12 A, rated voltage (III/2): 320 V, number of positions: 4, pitch: 5 mm, color: black, contact surface: Tin, mounting: THR soldering, User information and design recommendations for through hole reflow technology can be found under "Downloads"

Base strip - MSTB 2,5/ 4-G THT - 1963890



Header, nominal current: 12 A, rated voltage (III/2): 320 V, number of positions: 4, pitch: 5 mm, color: black, contact surface: Tin, mounting: THR soldering, User information and design recommendations for through hole reflow technology can be found under "Downloads"

Base strip - MSTBO 2,5/ 4-G1L THRR44 BK - 2697194



Header, nominal current: 16 A, rated voltage (III/2): 320 V, number of positions: 4, pitch: 5 mm, color: black, contact surface: Tin, mounting: Taped SMD/THT/THR components

Base strip - MSTBO 2,5/ 4-G1R THRR44 BK - 2697204



Header, nominal current: 16 A, rated voltage (III/2): 320 V, number of positions: 4, pitch: 5 mm, color: black, contact surface: Tin, mounting: Taped SMD/THT/THR components

Printed-circuit board connector - FKC 2,5/ 4-ST - 1910377

Accessories

Base strip - MSTBO 2,5/ 4-G1L KMGY - 2907774



Header, nominal current: 12 A, rated voltage (III/2): 320 V, number of positions: 4, pitch: 5 mm, color: light gray, contact surface: Tin, mounting: Soldering

Base strip - MSTBO 2,5/ 4-G1R KMGY - 2907787



Header, nominal current: 12 A, rated voltage (III/2): 320 V, number of positions: 4, pitch: 5 mm, color: light gray, contact surface: Tin, mounting: Soldering
