

Offers High-speed Input Response of 0.1 ms and Equipped with Built-in Timer



- High-speed response of 0.1 ms.
- Ideal as a two-input Controller.
- Lineup includes the S3D2-BK with flip-flop functions convenient for level control, the S3D2-AKD/CKD/CCD with 24-V power supply, and the S3D2-DK/EK with one input/output OFF-delay (two circuits) useful for load control and lamp display
- Power source for the Sensor can be supplied up to 200 mA.
- Ultra-slim body with 30-mm width.
- Multi-function model equipped with timer functions also available.



 Be sure to read *Safety Precautions* on page 7.

For the most recent information on models that have been certified for safety standards, refer to your OMRON website.

Ordering Information

Power supply voltage	Output	Timer function	Features	Model
100 to 240 VAC	Relay	No	Single-function with one input/output (two circuits)	S3D2-DK
		Yes		S3D2-EK
		No	Single-function with two inputs/one output (AND/OR operation)	S3D2-AK *
		No	Flip-flop function with two inputs/one output	S3D2-BK
		Yes	Multi-function with two inputs/one output	S3D2-CK *
	Yes	S3D2-CC *		
24 VDC	Relay	No	Single-function with two inputs/one output	S3D2-AKD
		Yes	Multi-function with two inputs/one output	S3D2-CKD
	Transistor	Yes		S3D2-CCD

* Models compatible with Sensors for PNP connections are also available. These model numbers have the suffix B (e.g., S3D2-AKB)

Differences from NPN Models

Input signals	ON	8 to 12 V (5 mA min.)
	OFF	0 to 4 V (2 mA max.)
	Maximum applied voltage	12 V

Note: S3D2-AK(B)/-CK(B)/-CC(B) models with UL certification are available. These model numbers have the suffix US (e.g., S3D2-AK-US).

Ratings and Specifications

Type		Two inputs/ two outputs		Two inputs/one output							
		Single- function	Single-func- tion (with OFF-delay)	Single-func- tion (AND/OR operation)	Flip-flop function	Multi-function		Single-func- tion (AND/OR operation)	Multi-function (24 VDC)		
Item	Model	S3D2-DK	S3D2-EK	S3D2-AK	S3D2-BK	S3D2-CK	S3D2-CC	S3D2-AKD	S3D2-CKD	S3D2-CCD	
Rated supply voltages		100 to 240 VAC \pm 10% 50/60Hz						24 VDC \pm 10%			
Power consumption		15 VA max.						2.5 VA max. (excluding Sensor power supply)			
Power supply for Sensor		12 VDC \pm 10% (includes all variations), 200 mA max. (with short-circuit protection)						24 VDC (supplied from power supply)			
Connected Sensor		NPN transistor output (with sinking current of 18 mA min.) or contact output									
Input signals	ON	0 to 4 V (5 mA min.)									
	OFF	8 to 12 V (2 mA max.)						8 to 30 V (2 mA max.)			
	Short-circuit current	11 mA TYP (18 mA max.)									
	Maximum applied voltage	30 V									
Input response time		0.1 ms			IN1 2 ms IN2 2 ms	0.1 ms					
Output minimum pulse width		10 ms max.				0.5 ms max.		10 ms max.		0.5 ms max.	
Control output		Relay output SPST-NO \times 2 250 VAC, 2A ($\cos\phi = 1$)		Relay output SPDT (shared common) 250 VAC, 3 A ($\cos\phi = 1$)			NPN open collector output, 30 VDC, 100 mA (NO, NC) Residual voltage (ON) 1.5 V max. Leakage current (OFF): 0.1 mA max.		Relay output SPDT 250 VAC, 3 A ($\cos\phi = 1$)		NPN open collector output, 30 VDC, 100 mA (NO, NC) Residual voltage (ON): 1.5 V max. Leakage current (OFF): 0.1 mA max.
Life expectancy (relay output)	Mechanical	50,000,000 operations min. (switching frequency: 18,000 operations/h)				---		50,000,000 operations min. (switching frequency: 18,000 operations/h)		---	
	Electrical	100,000 operations min. (switching frequency: 1,800 operations/h)				---		100,000 operations min. (switching frequency: 1,800 operations/h)		---	
Output response time		10 ms max.				0.5 ms max.		10 ms max.		0.5 ms max.	
Timer functions *		---	OFF-delay 0.1 to 1 s 1 to 10 s selectable	---	One-shot, ON-delay, and OFF-delay 0.1 to 1 s 1 to 10 s selectable		0.01 to 0.1 s 0.1 to 1 s selectable	---	One-shot, ON-delay, and OFF-delay 0.1 to 1 s 1 to 10 s selectable		
Other functions		Signal input reverse		<ul style="list-style-type: none"> Signal input reverse AND/OR operating mode selection by wiring 	<ul style="list-style-type: none"> Signal input reverse Flip-flop function 	<ul style="list-style-type: none"> Signal input reverse Sync mode selection AND/OR operating mode selection 	<ul style="list-style-type: none"> Signal input reverse AND/OR operating mode selection by wiring 	<ul style="list-style-type: none"> Signal input reverse Sync mode selection AND/OR operating mode selection 			
Maximum allowable time of momentary power failure		20 ms max.									
Ambient temperature range		Operating: -10 to $+55^{\circ}\text{C}$, Storage: -25 to $+65^{\circ}\text{C}$ (with no icing)									
Ambient humidity range		Operating/storage: 35% to 85%									
Noise immunity		Operating power supply: 1,500 V (p-p) min.; pulse width: 100 ns, 1 μs ; rise time: 1 ns Input/output: 1,200 V (p-p) min.; pulse width: 100 ns, 1 μs ; rise time: 1 ns						Operating power supply: 480 V (p-p) min.; pulse width: 100 ns, 1 μs ; rise time: 1 ns Input/output: 1,000 V (p-p) min.; pulse width: 100 ns, 1 μs ; rise time: 1 ns			
Dielectric strength		1,500 VAC min. (between power supply terminals and I/O terminals, and between non-current-carrying parts)						1,500 VAC min. (between power supply terminals and non-current-carrying parts)			
Vibration (destruction)		10 to 55 Hz, double-amplitude of 0.75 mm for 2 hours each of the X, Y, and Z directions									
Weight		Approx. 140 g									

* The timer will not operate in response to input signals received within 50 ms after the Controller power is turned ON.

Output Circuit Diagrams

Note: Numbers in parentheses indicate terminal pin numbers.

Relay Output Model

S3D2-AK/-AKD/
-CK/-CKD/-BK

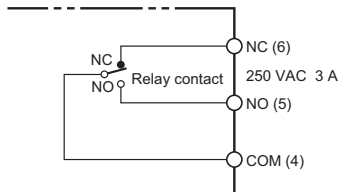

S3D2-DK/-EK

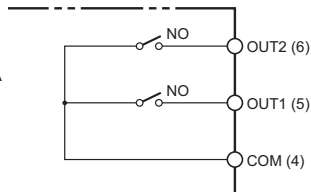

Open Collector Model

S3D2-CC/-CCD

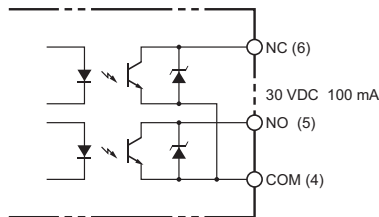

Input Circuit Diagrams

Note: Numbers in parentheses indicate terminal pin numbers.

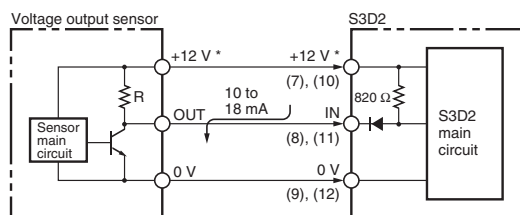

Note: Terminals (7) and (10), and (9) and (12) are connected internally.

* S3D2-AKD/-CKD/-CCD: +24 V

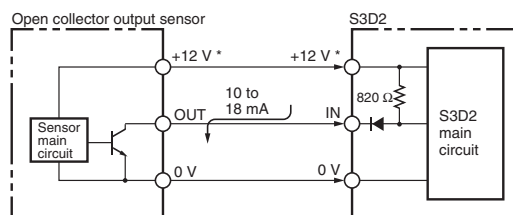

* S3D2-AKD/-CKD/-CCD: +24 V

Connections

Connection Methods

S3D2-AK



S3D2-AKD

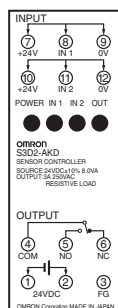

S3D2-CK



S3D2-CKD

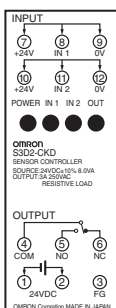

S3D2-CC



S3D2-CCD



S3D2-BK

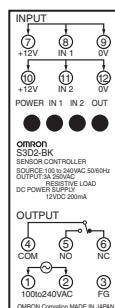

S3D2-DK/-EK



(1), (2): Power supply terminals

(3): FG terminal

Ground with a ground resistance of 100 Ω max. in locations subject to excessive noise.

(4) to (6): Output terminals

(7), (10): Power supply terminals for S3D2-AKD/-CKD/-CCD Sensors (+24 V), and other models (+12 V)

(9), (12): Power supply terminals for the Sensor (0 V)

(8), (11): Output terminals for the Sensor
Connect the Sensor output lines.

Sensor Connections

Two-wire Sensors (NPN Models)

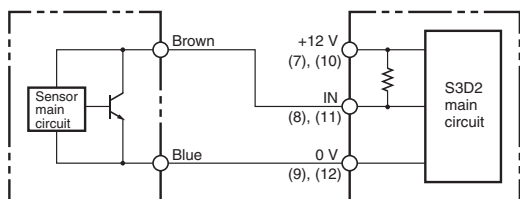

Note: Numbers in parentheses indicate terminal pin numbers.

Contact Output Sensors

- The S3D2 has a high-speed input response of 0.1 ms, which may cause contact output models (relay output, micro-switches, etc.) to receive unnecessary input from contact bounce and chattering.

Example of Unconnectable Sensor Model

Type	Proximity Sensor
Model	TL-G3D, TL-L100, etc.
Details	

Wired OR Transistor Output

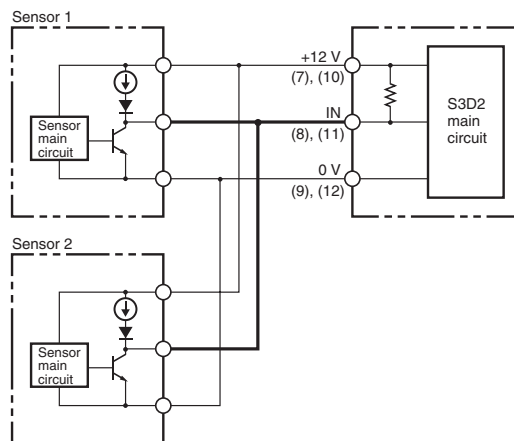

Note: Numbers in parentheses indicate terminal pin numbers.

- Wired OR for "Object Detected" Signals** (e.g., Proximity Sensors with NO Outputs)
The input would be an OR of "object detected" signals using a wired OR of Sensors that turn ON the output transistor when an object is detected. The S3D2's input signal selector switch can be set to reverse this operation and produce an input that would be an AND of "object not detected" signals.
- Wired OR for "Object Not Detected" Signals** (e.g., Proximity Sensors with NC Outputs)
The input would be an OR of "object not detected" signals using a wired OR of Sensors that turn ON the output transistor when an object is not detected. The S3D2's input signal selector switch can be set to reverse this operation and produce an input that would be an AND of "object detected" signals.

Load Connection

Connecting Loads to Collector Side

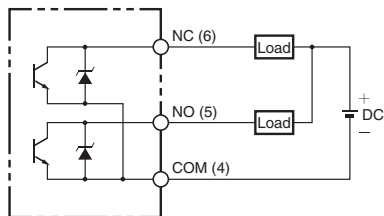

Connecting Loads to Emitter Side

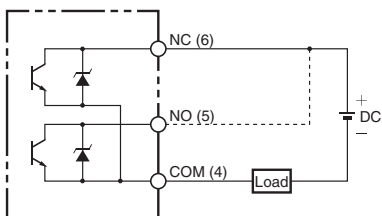

- Note: 1. Numbers in parentheses indicate terminal numbers.
2. Connect either the NC or NO terminals for the Emitter common. The solid line indicates the NC terminal and the broken line indicates the NO terminal.

Nomenclature

S3D2-AK/-AKD

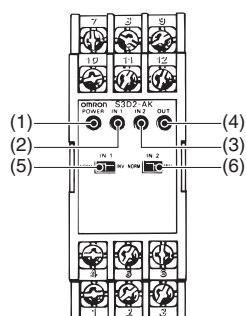

S3D2-CK/-CKD/-CC/-CCD

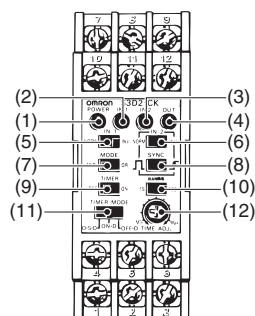

S3D2-BK

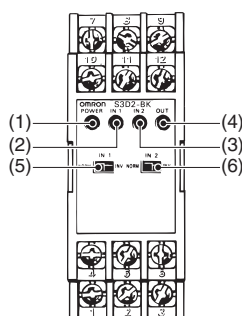

S3D2-DK

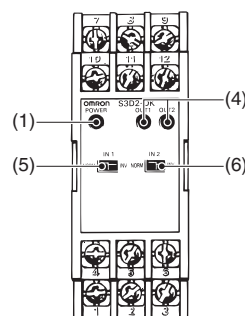

S3D2-EK

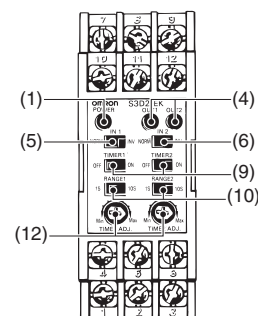

No.	Name	Functions
(1)	POWER indicator (green)	Lights when the operating power is turned ON and the Sensor power supply is output. Not lit when the operating power is turned OFF, or the Sensor power supply is short circuited (between the +12-V or +24-V terminal and 0-V terminal).
(2)	IN1 indicator (red)	Lights when the output from the Sensor connected to IN1 is received by IN1 as an input.
(3)	IN2 indicator (red)	Lights when the output from the Sensor connected to IN2 is received by IN2 as an input.
(4)	OUT indicator (red)	Lights when the output turns ON.
(5)	IN1 input signal selector switch	NORM: Input as a signal when the Sensor's output transistor (or contact output) is ON. INV: Input as a signal when the Sensor's output transistor (or contact output) is OFF.
(6)	IN2 input signal selector switch	
(7)	MODE (AND/OR operation selector switch)	AND: The output is turned ON when IN1 and IN2 input signals are both ON. OR: The output is turned ON when either IN1 or IN2 input signal is ON.
(8)	SYNC (synchronous mode selector switch) (This switch is enabled only when the AND/OR operation selector is set to AND.)	<input type="checkbox"/> : The output is turned ON while both IN1 and IN2 input signals are ON. <input checked="" type="checkbox"/> : If the input signal of IN2 is turned ON (at the rising edge) while the IN1 input signal is ON, the output is turned ON.*
(9)	TIMER switch	Turns timer operation ON/OFF. ON: Timer enabled OFF: Timer disabled
(10)	RANGE (Timer timing selector switch)	Changes the range for the timer setting time. • S3D2-CK/-EK 1 s: Setting time is in range from 0.1 to 1s. 10 s: Setting time is in range from 1 to 10s. • S3D2-CC 0.1 s: Setting time is in range from 0.01 to 0.1s. 1 s: Setting time is in range from 0.1 to 1s.
(11)	TIMER MODE (Timer operation mode switch)	O. S: One-shot timer ON. D: ON-delay timer OFF. D: OFF-delay timer
(12)	TIME ADJ. (Timer setting adjuster)	Setting time can be adjusted with the provided screwdriver. The adjuster rotates 190°.

* Be sure to set the one-shot timer.

Operation

Basic Operation

S3D2-AK□: Basic Operation

One Sensor

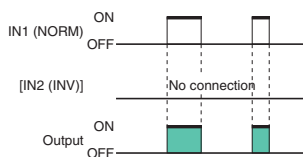

Note: When connecting only one Sensor, be sure to set the input selector switch for the unconnected Sensor to INV.

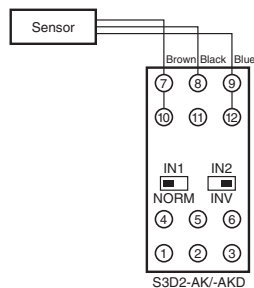

Two Sensors (AND Operation)

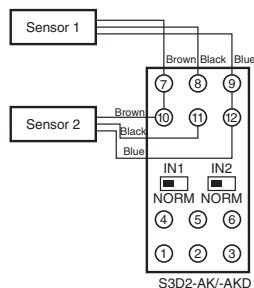
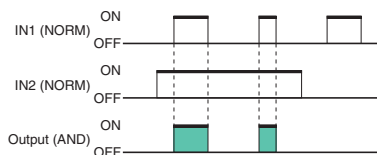

Two Sensors (OR Operation)

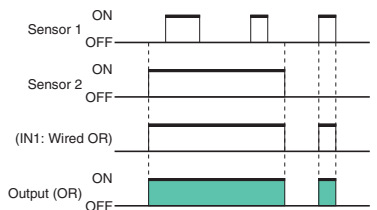

Note: When two Sensors are wired OR and then receive input (IN1 or IN2), OR operation is possible.

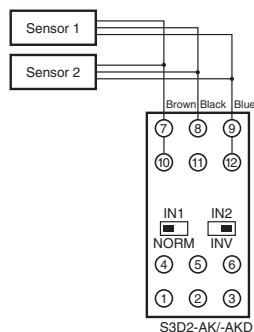

S3D2-AK□ default settings: IN1.....NORM, IN2.....INV.
If AND operation is used, set IN2 to NORM.

S3D2-BK: Flip-flop Operation

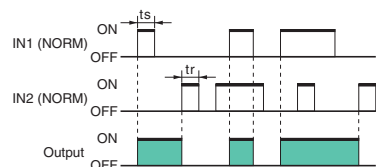

Note: $t_s \geq 2ms$, $t_r \geq 2ms$
 Input 1 (IN1) takes priority when both inputs 1 and 2 are received at the same time.

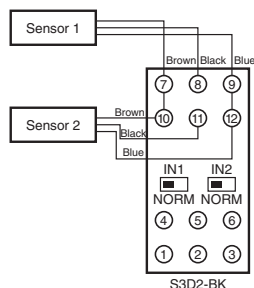

S3D2-CK□/CC□: Timer Operation (AND)

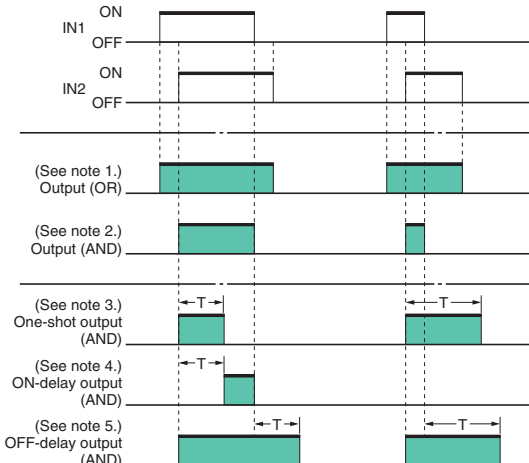

- Note: 1. IN1 and IN2 send OR outputs.
- 2. IN1 and IN2 send AND outputs.
- 3. IN1 and IN2 send AND outputs for T seconds from the rising edge.
- 4. IN1 and IN2 send AND outputs after a delay of T seconds from the rising edge.
- 5. IN1 and IN2 send AND outputs for T seconds from the falling edge.

When only one Sensor is connected to the S3D2-CK□ and S3D2-CC□, always set the AND/OR selector switch to OR

S3D2-DK/EK: Basic Operation

Two Input Signals Output Independently
 The S3D2-EK is equipped with an OFF-delay Timer.

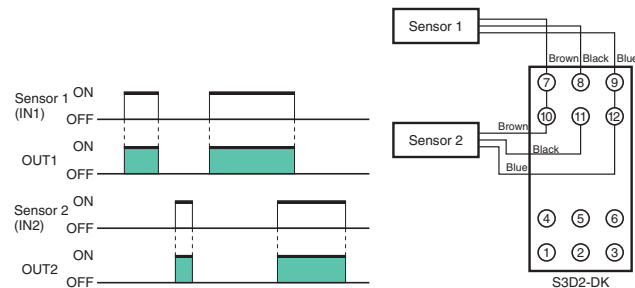

S3D2-DK/EK: One Sensor with Two Outputs

Terminals (8) and (11) are short-circuited.

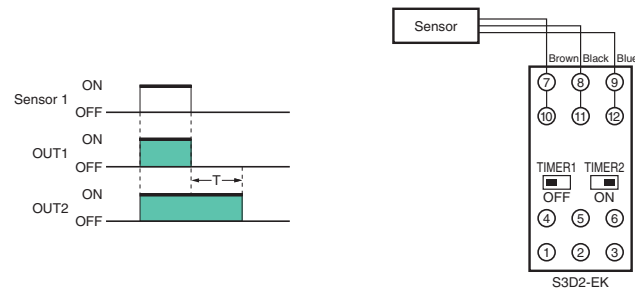

- Note: 1. The time chart above shows the operation for an S3D2-EK when the timer 1 switch is OFF and the timer 2 switch is ON.
- 2. Terminals (8) and (11) are short-circuited, and the current from the S3D2 to the Sensor is $18 \times 2 = 36$ mA max. (TYP 22 mA).

Safety Precautions

Refer to *Warranty and Limitations of Liability*.

⚠ WARNING

This product is not designed or rated for ensuring safety of persons either directly or indirectly. Do not use it for such purposes.



Precautions for Safe Use

- Be sure to connect the power supply to the power supply terminals correctly. Use a power supply with a voltage range of 100 to 240 VAC ± 10%.

Precautions for Correct Use

Do not use the product in atmospheres or environments that exceed product ratings.

● Wiring

Ground

- FG is a ground terminal. Ground this terminal at a ground resistance of 100 Ω max. when installing in locations subject to excessive noise, or if the S3D2 malfunctions.
- Do not share a ground line with other devices, or connect it to a structural beam of a building. Doing so will have the opposite effect, and may adversely affect the Sensor.

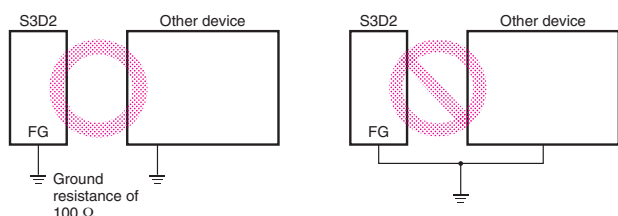

Storing in a Protective Case

- Take measures to provide adequate heat dissipation. Otherwise, heat radiation from the body of the S3D2 may cause the insides of protective casing to heat up.

S3D2-AKD/-CKD/-CCD

- Do not connect a load of 1 A min. to models for which the S3D2 power supply inputs are to be used as is for the Sensor power supply outputs. Connecting a load of 1 A min. to the Sensor's power supply outputs will cause the fuse in the case to break.

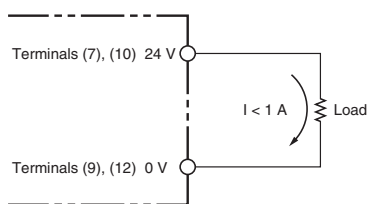

Output

- Connect a surge suppressor or diode in parallel to the load if an inductive load or other electrical part that generates noise is connected to the output.
- Connect the cathode side of the diode to the ⊕ side of the power supply.

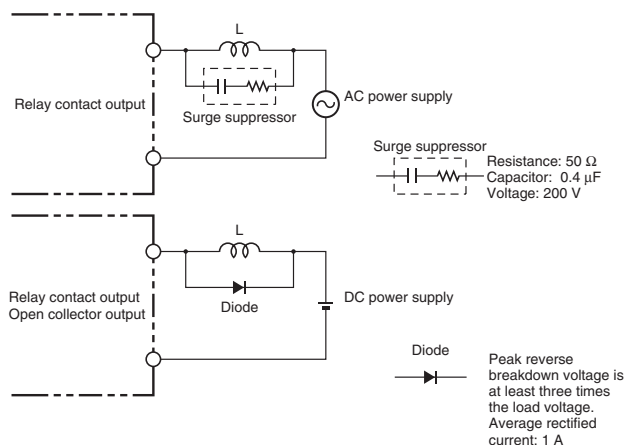

Output Relay Contact

(Not Including S3D2-CC/-CCD/-DK/-EK)

- When using a load (e.g., contactor or valve) that generates an arc when the circuit is broken, the NC (NO) contact may turn ON before the NO (NC) contact has opened (turned OFF).
- When using both NO and NC outputs at the same time, incorporate an arc suppressor (use the CR method, varistor, or other countermeasure).

● Mounting

Tightening Torque

Using the provided M3.5 screws, tighten the terminal block to a torque of 0.59 N·m max.

For direct mounting, use M4 screws, and tighten them to a torque of 0.78 N·m max.

Side-by-side Mounting

- When two or more S3D2 are mounted side by side, be sure to provide a minimum distance of 10 mm between them.

Note: Use the PFP-M End Plate for a space of 10 mm.

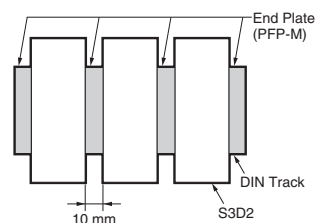

- If side-by-side mounting is unavoidable, refer to the following load derating curve.

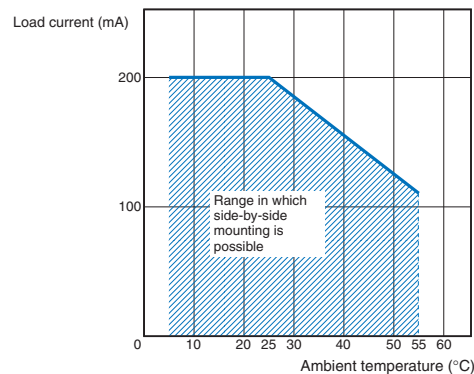

- Always lay the S3D2 input lines, output lines, and the power line separately. Otherwise, malfunction due to noise may occur.

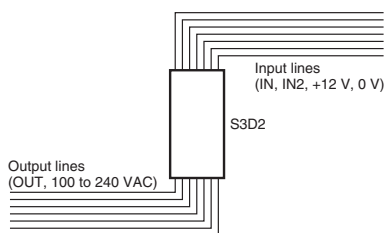

- The power line, through which a large current flows (e.g., to drive a motor) should be wired at least 200 mm away from the S3D2.

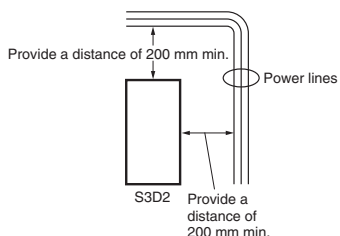

● Removing the Terminal Block Cover

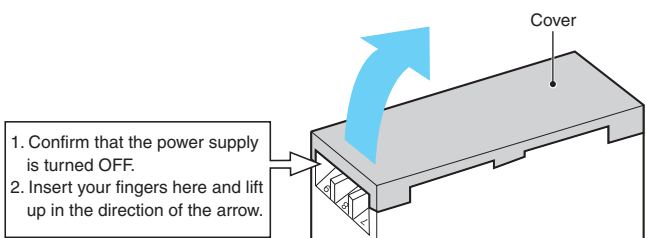

Dimensions

(Unit: mm)

S3D2

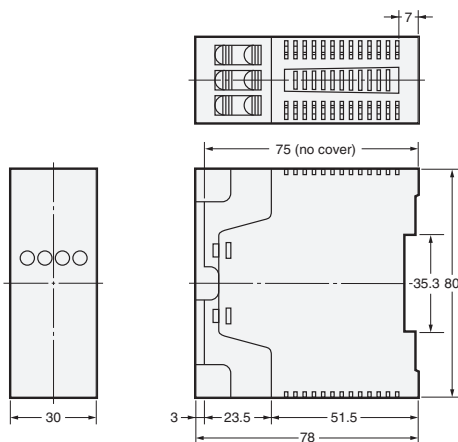
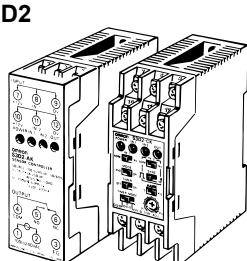

* Terminal block screws: M3.5

Mounting Holes (direct mounting)

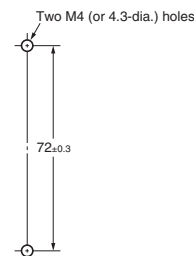

(DIN Track mounting is also possible.)

In the interest of product improvement, specifications are subject to change without notice.

Terms and Conditions Agreement

Read and understand this catalog.

Please read and understand this catalog before purchasing the products. Please consult your OMRON representative if you have any questions or comments.

Warranties.

(a) Exclusive Warranty. Omron's exclusive warranty is that the Products will be free from defects in materials and workmanship for a period of twelve months from the date of sale by Omron (or such other period expressed in writing by Omron). Omron disclaims all other warranties, express or implied.

(b) Limitations. OMRON MAKES NO WARRANTY OR REPRESENTATION, EXPRESS OR IMPLIED, ABOUT NON-INFRINGEMENT, MERCHANTABILITY OR FITNESS FOR A PARTICULAR PURPOSE OF THE PRODUCTS. BUYER ACKNOWLEDGES THAT IT ALONE HAS DETERMINED THAT THE PRODUCTS WILL SUITABLY MEET THE REQUIREMENTS OF THEIR INTENDED USE.

Omron further disclaims all warranties and responsibility of any type for claims or expenses based on infringement by the Products or otherwise of any intellectual property right. (c) Buyer Remedy. Omron's sole obligation hereunder shall be, at Omron's election, to (i) replace (in the form originally shipped with Buyer responsible for labor charges for removal or replacement thereof) the non-complying Product, (ii) repair the non-complying Product, or (iii) repay or credit Buyer an amount equal to the purchase price of the non-complying Product; provided that in no event shall Omron be responsible for warranty, repair, indemnity or any other claims or expenses regarding the Products unless Omron's analysis confirms that the Products were properly handled, stored, installed and maintained and not subject to contamination, abuse, misuse or inappropriate modification. Return of any Products by Buyer must be approved in writing by Omron before shipment. Omron Companies shall not be liable for the suitability or unsuitability or the results from the use of Products in combination with any electrical or electronic components, circuits, system assemblies or any other materials or substances or environments. Any advice, recommendations or information given orally or in writing, are not to be construed as an amendment or addition to the above warranty.

See <http://www.omron.com/global/> or contact your Omron representative for published information.

Limitation on Liability: Etc.

OMRON COMPANIES SHALL NOT BE LIABLE FOR SPECIAL, INDIRECT, INCIDENTAL, OR CONSEQUENTIAL DAMAGES, LOSS OF PROFITS OR PRODUCTION OR COMMERCIAL LOSS IN ANY WAY CONNECTED WITH THE PRODUCTS, WHETHER SUCH CLAIM IS BASED IN CONTRACT, WARRANTY, NEGLIGENCE OR STRICT LIABILITY.

Further, in no event shall liability of Omron Companies exceed the individual price of the Product on which liability is asserted.

Suitability of Use.

Omron Companies shall not be responsible for conformity with any standards, codes or regulations which apply to the combination of the Product in the Buyer's application or use of the Product. At Buyer's request, Omron will provide applicable third party certification documents identifying ratings and limitations of use which apply to the Product. This information by itself is not sufficient for a complete determination of the suitability of the Product in combination with the end product, machine, system, or other application or use. Buyer shall be solely responsible for determining appropriateness of the particular Product with respect to Buyer's application, product or system. Buyer shall take application responsibility in all cases.

NEVER USE THE PRODUCT FOR AN APPLICATION INVOLVING SERIOUS RISK TO LIFE OR PROPERTY OR IN LARGE QUANTITIES WITHOUT ENSURING THAT THE SYSTEM AS A WHOLE HAS BEEN DESIGNED TO ADDRESS THE RISKS, AND THAT THE OMRON PRODUCT(S) IS PROPERLY RATED AND INSTALLED FOR THE INTENDED USE WITHIN THE OVERALL EQUIPMENT OR SYSTEM.

Programmable Products.

Omron Companies shall not be responsible for the user's programming of a programmable Product, or any consequence thereof.

Performance Data.

Data presented in Omron Company websites, catalogs and other materials is provided as a guide for the user in determining suitability and does not constitute a warranty. It may represent the result of Omron's test conditions, and the user must correlate it to actual application requirements. Actual performance is subject to the Omron's Warranty and Limitations of Liability.

Change in Specifications.

Product specifications and accessories may be changed at any time based on improvements and other reasons. It is our practice to change part numbers when published ratings or features are changed, or when significant construction changes are made. However, some specifications of the Product may be changed without any notice. When in doubt, special part numbers may be assigned to fix or establish key specifications for your application. Please consult with your Omron's representative at any time to confirm actual specifications of purchased Product.

Errors and Omissions.

Information presented by Omron Companies has been checked and is believed to be accurate; however, no responsibility is assumed for clerical, typographical or proofreading errors or omissions.