

PLEASE CHECK WWW.MOLEX.COM FOR LATEST PART INFORMATION

Part Number: [0874390300](#)
Status: **Active**
Overview: Pico-SPOX™ Wire-to-Board Connector System
Description: 1.50mm Pitch Pico-SPOX™ Wire-to-Board Housing, 3 Circuits, Off-White Housing

Documents:

3D Model	Packaging Specification SPK-87439-001-001 (PDF)
Drawing (PDF)	RoHS Certificate of Compliance (PDF)
Product Specification PS-87437-001-001 (PDF)	Product Literature (PDF)

Agency Certification

CSA	LR19980
UL	E29179

General

Product Family	Crimp Housings
Series	87439
Application	Signal, Wire-to-Board
MolexKits	Yes
Overview	Pico-SPOX™ Wire-to-Board Connector System
Product Literature Order No	USA-235
Product Name	Pico-SPOX™
UPC	800753537217

Physical

Circuits (maximum)	3
Color - Resin	Natural
Flammability	94V-0
Gender	Receptacle
Glow-Wire Compliant	No
Lock to Mating Part	Yes
Material - Resin	Nylon
Net Weight	40.000/mg
Number of Rows	1
Packaging Type	Bag
Panel Mount	No
Pitch - Mating Interface	1.50mm
Polarized to Mating Part	Yes
Stackable	No
Temperature Range - Operating	-55°C to +105°C

Electrical

Current - Maximum per Contact	2.5A
-------------------------------	------

Material Info

Reference - Drawing Numbers

Packaging Specification	SPK-87439-001-001
Product Specification	PS-87437-001-001
Sales Drawing	SD-87439-**00

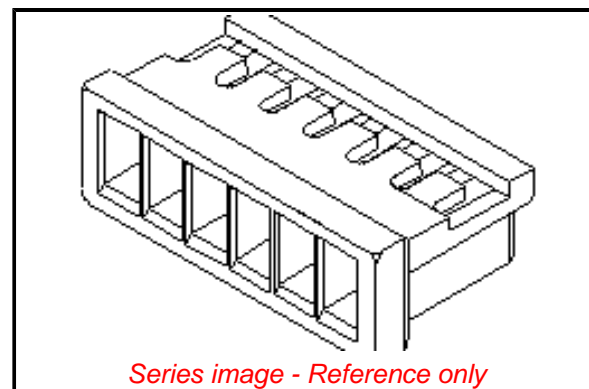

EU ELV

Not Relevant

EU RoHS

Compliant

REACH SVHC

Not Contained Per -
ED/30/2017 (7 July
2017)

Halogen-Free

Status

Low-Halogen

**Need more information on product
environmental compliance?**

Email productcompliance@molex.com
Please visit the [Contact Us](#) section for any
non-product compliance questions.

China ROHS	Green Image
ELV	Not Relevant
RoHS Phthalates	Not Contained

Search Parts in this Series

[87439](#) Series

Mates With

Pico-SPOX™ Wire-to-Board Header [87437](#) ,
[87438](#)

Use With

[87421](#) Pico-SPOX™ Crimp Terminal