

## Product Overview

This family of 2N5415 and 2N5416 epitaxial planar transistors are military qualified up to a JANS level for high-reliability applications per MIL-PRF-19500/485. These devices are also available in TO-39 and low profile U4 and UA packaging.

Qualified Levels: JAN, JANTX, JANTXV and JANS.

**Figure 1.** TO-5 Package

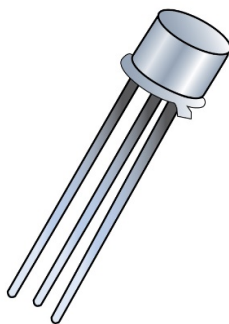

Also available in:

**TO-205AD (TO-39) package (short-leaded)**

[2N5415S – 2N5416S](#)

**U4 package (surface mount)**

[2N5415U4 – 2N5416U4](#)

**UA package (surface mount)**

[2N5415UA – 2N5416UA](#)

### Features

- JEDEC registered 2N5415 through 2N5416 series
- JAN, JANTX, JANTXV, and JANS qualifications are available per MIL-PRF-19500/485. (See [Part Nomenclature](#) for all available options.)
- RoHS compliant

### Applications/Benefits

- General purpose transistors for low power applications requiring high frequency switching.
- Low package profile
- Military and other high-reliability applications

## Table of Contents

Product Overview.....	1
1. Maximum Ratings.....	3
1.1. Mechanical Packaging.....	3
2. Part Nomenclature.....	4
2.1. Symbols and Definitions.....	4
3. Electrical Characteristics at $T_A = +25\text{ }^\circ\text{C}$ , Unless Otherwise Noted.....	5
4. Graphs.....	7
5. Package Dimensions.....	9
6. Revision History.....	11
Microchip Information.....	12
Trademarks.....	12
Legal Notice.....	12
Microchip Devices Code Protection Feature.....	12

# 1. Maximum Ratings

**Table 1-1.** Maximum Ratings at 25 °C Unless Otherwise Noted

Parameters / Test Conditions	Symbol	2N5415	2N5416	Unit
Collector-Emitter voltage	$V_{CEO}$	200	300	V
Collector-Base voltage	$V_{CBO}$	200	350	V
Emitter-Base voltage	$V_{EBO}$	6.0	6.0	V
Collector current	$I_C$	1.0	1.0	A
Operating and storage junction temperature range	$T_J, T_{stg}$	-65 to +200		°C
Thermal resistance junction-to-ambient	$R_{\theta JA}$	234		°C/W
Thermal resistance junction-to-case	$R_{\theta JC}$	17.5		°C/W
Total power dissipation	$P_T$	at $T_A = +25\text{ °C}$ <sup>1</sup>	0.75	W
		at $T_C = +25\text{ °C}$ <sup>2</sup>	10	

**Notes:**

- Derate linearly 4.29 mW/°C for  $T_A > +25\text{ °C}$
- Derate linearly 57.2 mW/°C for  $T_C > +25\text{ °C}$

## 1.1 Mechanical Packaging

- Case: Hermetically sealed, kovar base, nickel cap
- Terminals: Leads are gold plated kovar. Solder dip (Sn63/Pb37) is available upon special request.  
**Note:** Solder dipping will eliminate RoHS compliance.
- Marking: Part number, date code, manufacturer's ID
- Polarity: NPN
- Weight: Approximately 1.14 grams
- See [Package Dimensions](#).

## 2. Part Nomenclature

Figure 2-1. Part Nomenclature

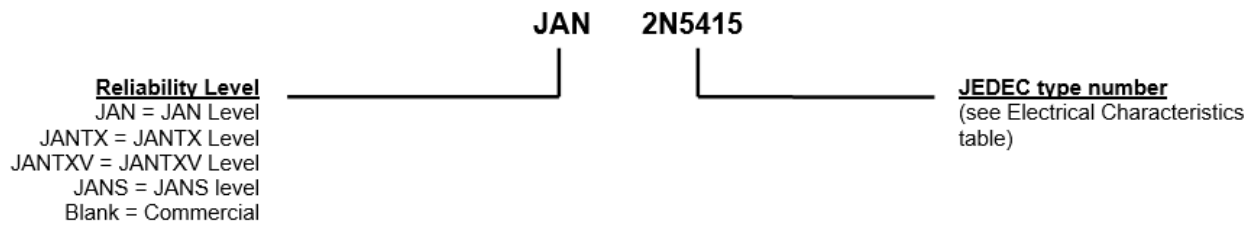

### 2.1 Symbols and Definitions

Table 2-1. Symbols and Definitions

Symbol	Definition
$C_{obo}$	Common-base open-circuit output capacitance
$I_{CEO}$	Collector cutoff current, base open
$I_{CEX}$	Collector cutoff current, circuit between base and emitter
$I_{EBO}$	Emitter cutoff current, collector open
$h_{FE}$	Common-emitter static forward current transfer ratio
$V_{CEO}$	Collector-emitter voltage, base open
$V_{CBO}$	Collector-base voltage, emitter open
$V_{EBO}$	Emitter-base voltage, collector open

### 3. Electrical Characteristics at $T_A = +25\text{ }^\circ\text{C}$ , Unless Otherwise Noted

**Table 3-1. Off Characteristics**

Parameters/Test Conditions	Symbol	Min.	Max.	Unit	
Collector-Emitter breakdown voltage					
$I_C = 50\text{ mA}$ , $I_B = 5\text{ mA}$ , $L = 25\text{ mH}$ ; $f = 30\text{--}60\text{ Hz}$	2N5415 2N5416	$V_{(BR)CEO}$	200 300	— —	V
Emitter-Base cutoff current $V_{EB} = 6.0\text{V}$		$I_{EBO}$	—	20	$\mu\text{A}$
Collector-Emitter cutoff current					
$V_{CE} = 200\text{V}$ , $V_{BE} = 1.5\text{V}$ $V_{CE} = 300\text{V}$ , $V_{BE} = 1.5\text{V}$	2N5415 2N5416	$I_{CEX}$	—	50	$\mu\text{A}$
Collector-Emitter cutoff current					
$V_{CE} = 150\text{V}$ $V_{CE} = 250\text{V}$	2N5415 2N5416	$I_{CEO1}$	—	50	$\mu\text{A}$
Collector-Emitter cutoff current					
$V_{CE} = 200\text{V}$ $V_{CE} = 300\text{V}$	2N5415 2N5416	$I_{CEO2}$	—	1	mA
Collector-Base cutoff current					
$V_{CB} = 175\text{V}$ $V_{CB} = 280\text{V}$	2N5415 2N5416	$I_{CBO1}$	—	50	$\mu\text{A}$
$V_{CB} = 200\text{V}$ $V_{CB} = 350\text{V}$	2N5415 2N5416	$I_{CBO2}$	—	500	$\mu\text{A}$
$V_{CB} = 175\text{V}$ , $T_A = +150\text{ }^\circ\text{C}$ $V_{CB} = 280\text{V}$ , $T_A = +150\text{ }^\circ\text{C}$	2N5415 2N5416	$I_{CBO3}$	—	1	mA

**Table 3-2. On Characteristics**

Parameters/Test Conditions	Symbol	Min.	Max.	Unit
Forward-Current transfer ratio $I_C = 50\text{ mA}$ , $V_{CE} = 10\text{V}$ $I_C = 1\text{ mA}$ , $V_{CE} = 10\text{V}$ $I_C = 50\text{ mA}$ , $V_{CE} = 10\text{V}$ , $T_A = +150\text{ }^\circ\text{C}$	$h_{FE}$	30 15 15	120	—
Collector-Emitter saturation voltage $I_C = 50\text{ mA}$ , $I_B = 5\text{ mA}$	$V_{CE(sat)}$	—	2.0	V
Base-Emitter voltage non-saturation $I_C = 50\text{ mA}$ , $V_{CE} = 10\text{V}$	$V_{BE}$	—	1.5	V

**Table 3-3. Dynamic Characteristics**

Parameters/Test Conditions	Symbol	Min.	Max.	Unit
Magnitude of common emitter small-signal short-circuit forward current transfer ratio $I_C = 10\text{ mA}$ , $V_{CE} = 10\text{V}$ , $f = 5\text{ MHz}$	$ h_{fe} $	3	15	—
Small-signal short circuit forward-current transfer ratio $I_C = 5\text{ mA}$ , $V_{CE} = 10\text{V}$ , $f \leq 1\text{ kHz}$	$h_{fe}$	25	—	—

.....continued

Parameters/Test Conditions	Symbol	Min.	Max.	Unit
Output capacitance $V_{CB} = 10V, I_E = 0, 100 \text{ kHz} \leq f \leq 1 \text{ MHz}$	$C_{obo}$	—	15	pF

**Table 3-4.** Switching Characteristics

Parameters/Test Conditions	Symbol	Min.	Max.	Unit
Turn-On time $V_{CC} = 200V, I_C = 50 \text{ mA}, I_{B1} = 5 \text{ mA}$	$t_{on}$	—	1	$\mu\text{s}$
Turn-Off time $V_{CC} = 200V, I_C = 50 \text{ mA}, I_{B1} = I_{B2} = 5 \text{ mA}$	$t_{off}$	—	10	$\mu\text{s}$

**Safe Operating Area**

- DC Tests  
 $T_C = +25 \text{ }^\circ\text{C}, t_p = 0.4 \text{ seconds}, 1 \text{ Cycle}$
- Test 1  
 $V_{CE} = 10V, I_C = 1 \text{ A}$
- Test 2  
 $V_{CE} = 100V, I_C = 100 \text{ mA}$
- Test 3  
 $V_{CE} = 200V, I_C = 24 \text{ mA}$  (2N5415 only)
- Test 4  
 $V_{CE} = 300V, I_C = 10 \text{ mA}$  (2N5416 only)

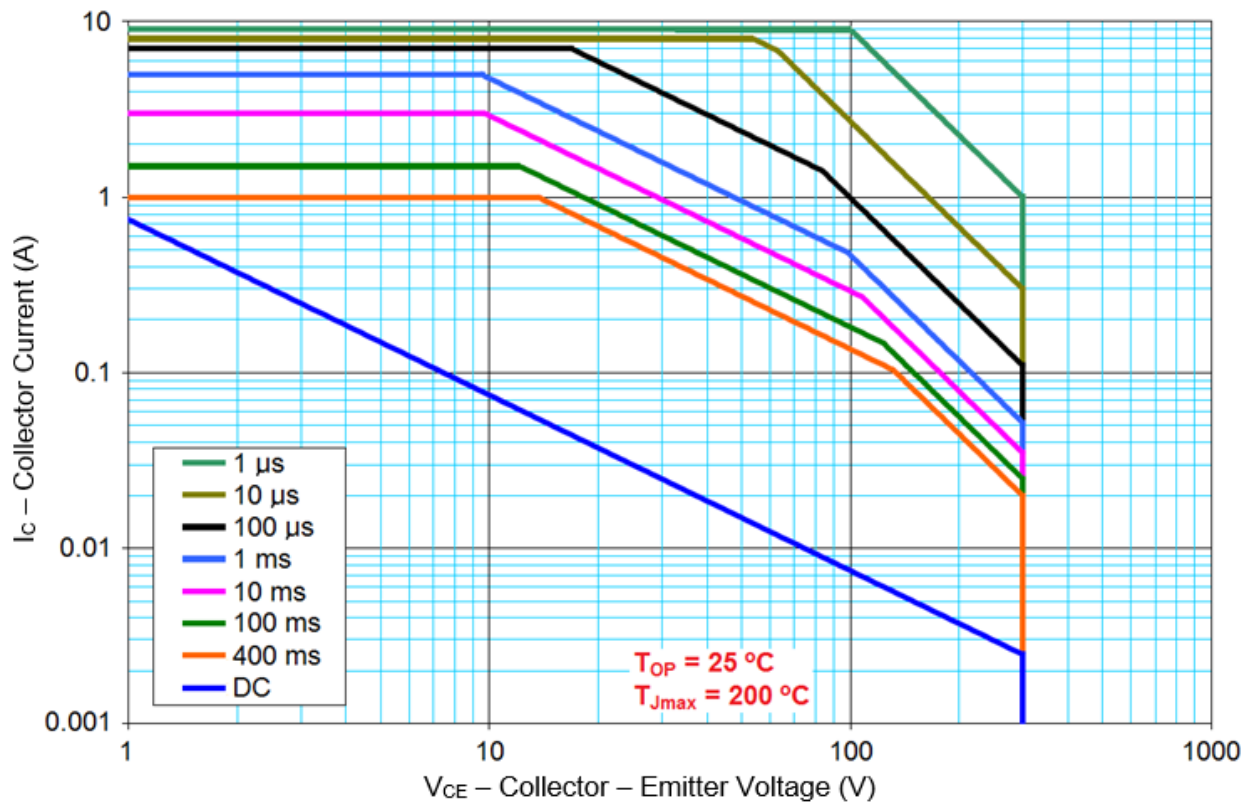
**Figure 3-1.** Maximum Safe Operating Area ( $T_J = 200 \text{ }^\circ\text{C}$ )

## 4. Graphs

Figure 4-1. Thermal Impedance Graph ( $R_{\theta JA}$ )

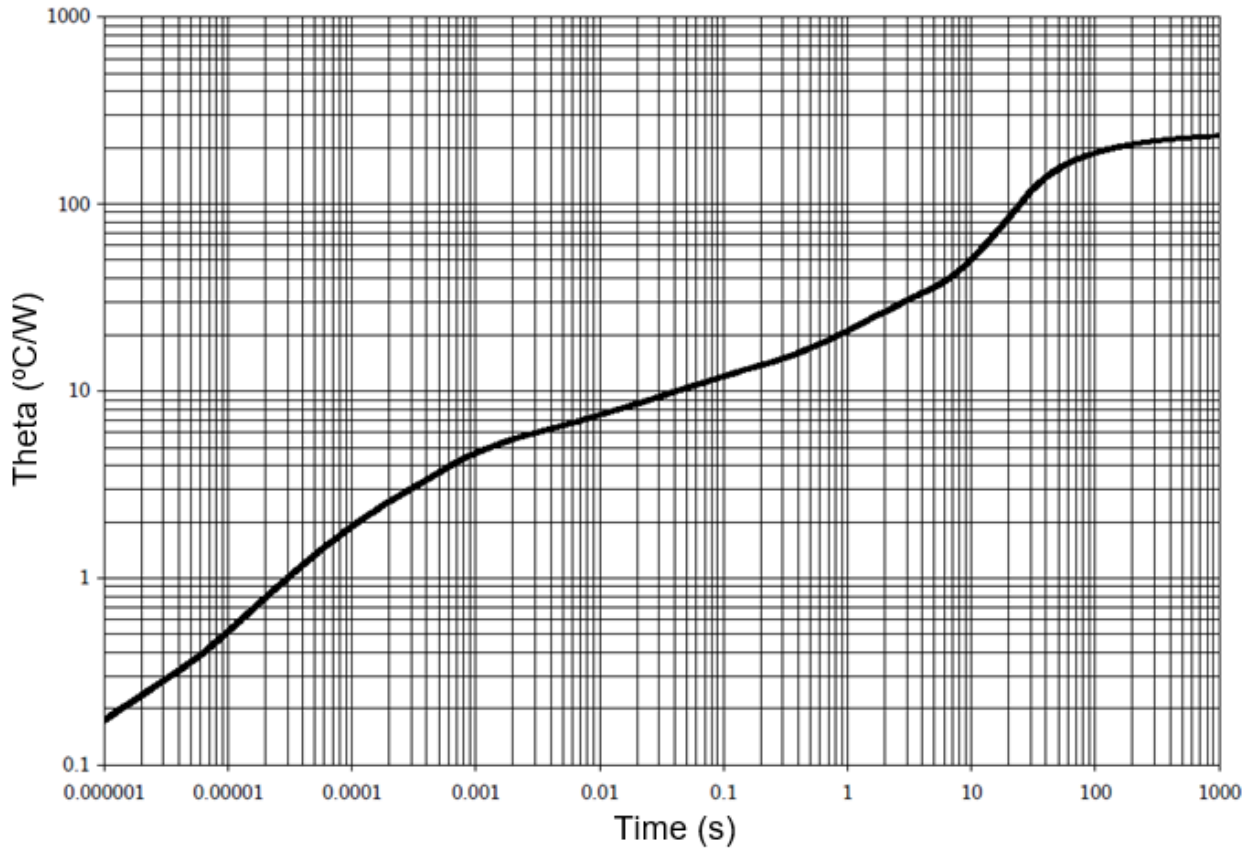
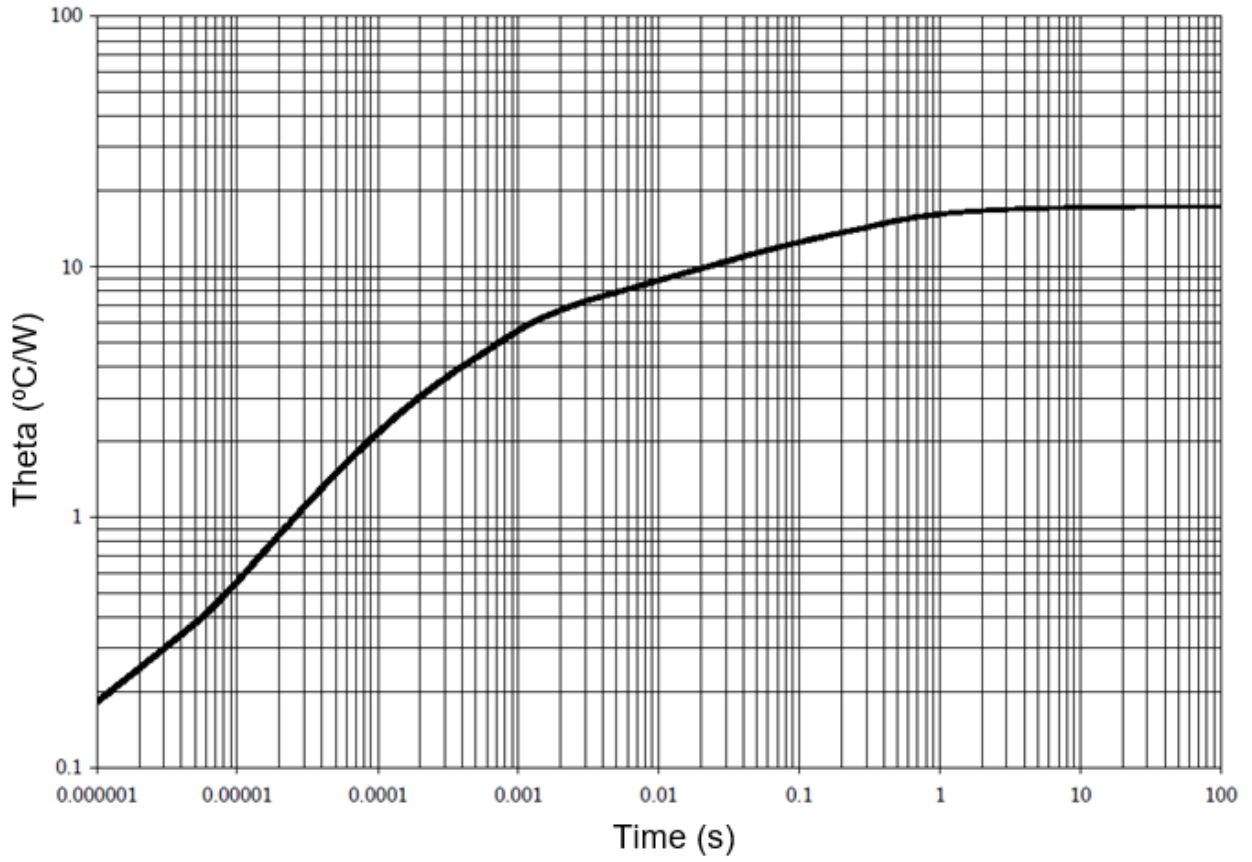

Figure 4-2. Thermal Impedance Graph ( $R_{\theta JA}$ )





## 5. Package Dimensions

Figure 5-1. Package Dimensions

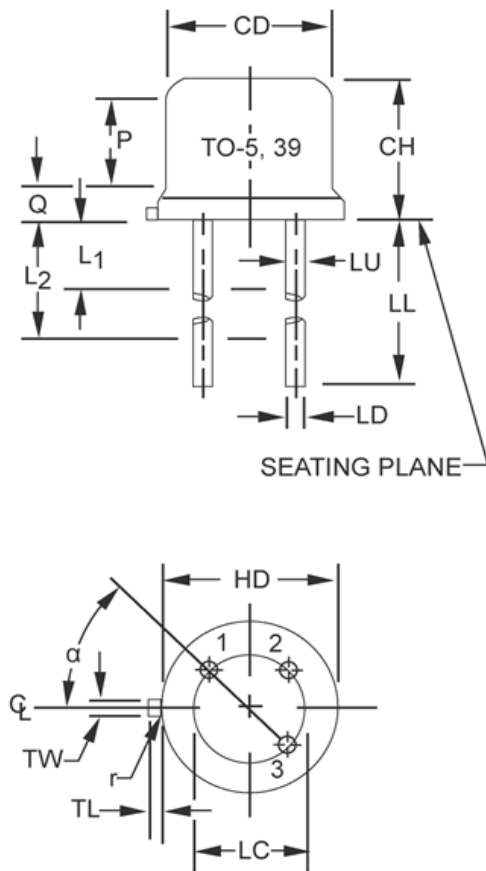

Symbol	Dimensions				Note
	Inch		Millimeters		
	Min.	Max.	Min.	Max.	
CD	0.305	0.335	7.75	8.51	—
CH	0.240	0.260	6.10	6.60	—
HD	0.335	0.370	8.51	9.40	—
LC	0.200 TP		5.08 TP		6
LD	0.016	0.021	0.41	0.53	7
LL	See notes 7, 12, and 13				—
LU	0.016	0.019	0.41	0.48	7, 13
L1	—	0.050	—	1.27	13
L2	0.250	—	6.35	—	13
P	0.100	—	2.54	—	5
Q	—	0.050	—	1.27	4
TL	0.029	0.045	0.74	1.14	3
TW	0.028	0.034	0.71	0.86	10, 11
r	—	0.010	—	0.25	11
α	45° TP		45° TP		6

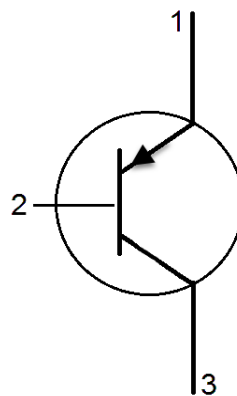

**Notes:**

1. Dimensions are in inches.
2. Millimeters are given for information only.
3. Symbol TL is measured from HD maximum.
4. Details of outline in this zone are optional.
5. Symbol CD shall not vary more than 0.010 (0.25 mm) in zone P. This zone is controlled for automatic handling.
6. Leads at gauge plane 0.054 inch (1.37 mm) +0.001 inch (0.03 mm) -0.000 inch (0.00 mm) below seating plane shall be within 0.007 inch (0.18 mm) radius of true position (TP) relative to tab. Device may be measured by direct methods or by gauge.
7. Symbol LD applies between L1 and L2. Dimension LD applies between L2 and LL minimum. Lead diameter shall not exceed 0.042 inch (1.07 mm) within L1 and beyond LL minimum.
8. Lead designation, shall be as follows: 1 - emitter, 2 - base, 3 - collector.
9. Lead number three is electrically connected to case.
10. Beyond r maximum, TW shall be held for a minimum length of 0.011 inch (0.28 mm).
11. Symbol r applied to both inside corners of tab.
12. For transistor types 2N5415 and 2N5416, dimension LL shall be 1.5 inches (38.1 mm) minimum and 1.75 inch (44.4 mm) maximum.
13. All three leads
14. In accordance with ASME Y14.5M, diameters are equivalent to  $\Phi$ x symbology.

## 6. Revision History

The revision history describes the changes that were implemented in the document. The changes are listed by revision, starting with the most current publication.

Revision	Date	Description
B	12/2024	Updated links to Microchip website.
A	12/2024	Document converted to Microchip template and assigned literature number DS00005746.
Rev. 1	07/2013	Microsemi document LDS-0305 was created.

## Microchip Information

### Trademarks

The “Microchip” name and logo, the “M” logo, and other names, logos, and brands are registered and unregistered trademarks of Microchip Technology Incorporated or its affiliates and/or subsidiaries in the United States and/or other countries (“Microchip Trademarks”). Information regarding Microchip Trademarks can be found at <https://www.microchip.com/en-us/about/legal-information/microchip-trademarks>.

ISBN: 979-8-3371-0277-1

### Legal Notice

This publication and the information herein may be used only with Microchip products, including to design, test, and integrate Microchip products with your application. Use of this information in any other manner violates these terms. Information regarding device applications is provided only for your convenience and may be superseded by updates. It is your responsibility to ensure that your application meets with your specifications. Contact your local Microchip sales office for additional support or, obtain additional support at [www.microchip.com/en-us/support/design-help/client-support-services](http://www.microchip.com/en-us/support/design-help/client-support-services).

THIS INFORMATION IS PROVIDED BY MICROCHIP “AS IS”. MICROCHIP MAKES NO REPRESENTATIONS OR WARRANTIES OF ANY KIND WHETHER EXPRESS OR IMPLIED, WRITTEN OR ORAL, STATUTORY OR OTHERWISE, RELATED TO THE INFORMATION INCLUDING BUT NOT LIMITED TO ANY IMPLIED WARRANTIES OF NON-INFRINGEMENT, MERCHANTABILITY, AND FITNESS FOR A PARTICULAR PURPOSE, OR WARRANTIES RELATED TO ITS CONDITION, QUALITY, OR PERFORMANCE.

IN NO EVENT WILL MICROCHIP BE LIABLE FOR ANY INDIRECT, SPECIAL, PUNITIVE, INCIDENTAL, OR CONSEQUENTIAL LOSS, DAMAGE, COST, OR EXPENSE OF ANY KIND WHATSOEVER RELATED TO THE INFORMATION OR ITS USE, HOWEVER CAUSED, EVEN IF MICROCHIP HAS BEEN ADVISED OF THE POSSIBILITY OR THE DAMAGES ARE FORESEEABLE. TO THE FULLEST EXTENT ALLOWED BY LAW, MICROCHIP’S TOTAL LIABILITY ON ALL CLAIMS IN ANY WAY RELATED TO THE INFORMATION OR ITS USE WILL NOT EXCEED THE AMOUNT OF FEES, IF ANY, THAT YOU HAVE PAID DIRECTLY TO MICROCHIP FOR THE INFORMATION.

Use of Microchip devices in life support and/or safety applications is entirely at the buyer’s risk, and the buyer agrees to defend, indemnify and hold harmless Microchip from any and all damages, claims, suits, or expenses resulting from such use. No licenses are conveyed, implicitly or otherwise, under any Microchip intellectual property rights unless otherwise stated.

### Microchip Devices Code Protection Feature

Note the following details of the code protection feature on Microchip products:

- Microchip products meet the specifications contained in their particular Microchip Data Sheet.
- Microchip believes that its family of products is secure when used in the intended manner, within operating specifications, and under normal conditions.
- Microchip values and aggressively protects its intellectual property rights. Attempts to breach the code protection features of Microchip products are strictly prohibited and may violate the Digital Millennium Copyright Act.
- Neither Microchip nor any other semiconductor manufacturer can guarantee the security of its code. Code protection does not mean that we are guaranteeing the product is “unbreakable”. Code protection is constantly evolving. Microchip is committed to continuously improving the code protection features of our products.