

**SERIES:** SDI65-U | **DESCRIPTION:** AC-DC POWER SUPPLY

**FEATURES**

- DoE Level VI, CoC Tier 2 efficiency
- 65 W power
- universal input (90~264 Vac)
- compact size
- single regulated output from 12~48 Vdc
- over voltage and short circuit protections
- UL/cUL and PSE safety approvals
- custom designs available
- certified to 60950-1 and 62368-1 standards



MODEL	output voltage	output current max	output power max	ripple and noise <sup>1</sup> max	efficiency level <sup>2</sup>
	(Vdc)	(A)	(W)	(mVp-p)	
SDI65-12-U	12	5	60	120	VI
SDI65-15-U	15	4.34	65	150	VI
SDI65-18-U	18	3.62	65	180	VI
SDI65-19-U	19	3.43	65	190	VI
SDI65-24-U	24	2.71	65	240	VI
SDI65-48-U	48	1.36	65	480	VI
SDI65-56-U	56	1.17	65.52	560	VI

Notes: 1. At full load, nominal input, 20 MHz bandwidth oscilloscope, each output terminated with 0.1 µF multilayer ceramic and 10 µF low ESR electrolytic capacitors.  
2. CoC Tier 2 compliant

**PART NUMBER KEY**

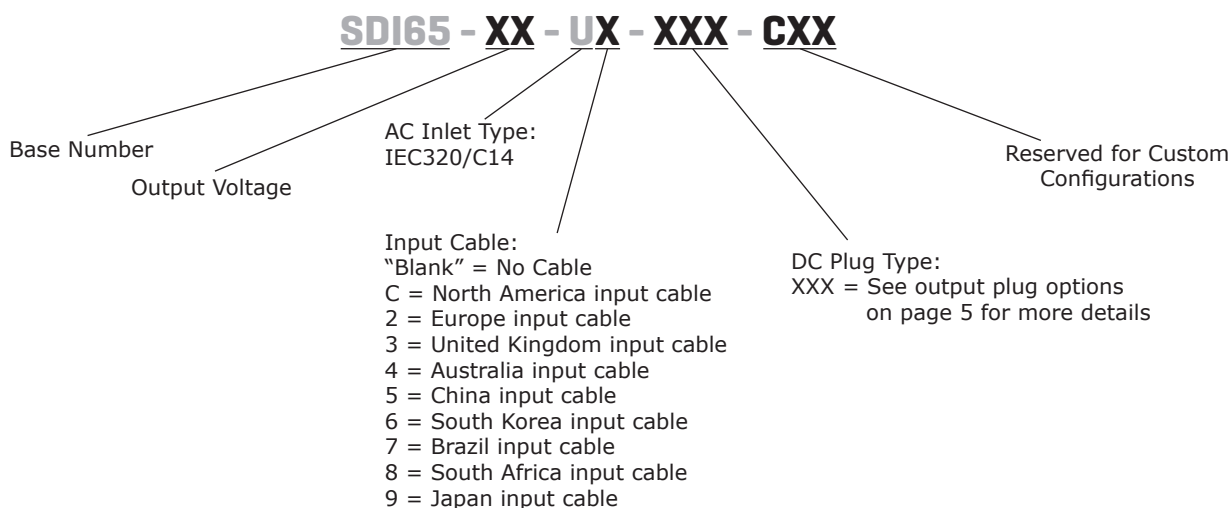

**INPUT**

parameter	conditions/description	min	typ	max	units
voltage		90	100~240	264	Vac
frequency		47	50~60	63	Hz
current				1.4	A
inrush current	at 240 Vac, full load, 25°C, cold start			80	A
leakage current				3.5	mA
no load power consumption	at 230 Vac			0.150	W

**OUTPUT**

parameter	conditions/description	min	typ	max	units
regulation			±5		%

**PROTECTIONS**

parameter	conditions/description	min	typ	max	units
over voltage protection	output latch off			150	%
over current protection	output shut down, auto recovery			180	%
short circuit protection	output shut down, auto recovery				

**SAFETY & COMPLIANCE**

parameter	conditions/description	min	typ	max	units
isolation voltage	input to output at 10 mA for 1 minute		3,000		Vac
	input to frame ground at 10 ma for 1 minute		1,500		Vac
isolation resistance	input to output at 500 Vdc	10			MΩ
	input to frame ground at 500 Vdc	10			MΩ
safety approvals	UL/cUL (60950-1, 62368-1), PSE, LPS, UKCA				
EMI/EMC	FCC Part 15B Class B, CE				
MTBF	as per Telcordia SR-332, 25°C	300,000			hours
RoHS	yes				

**ENVIRONMENTAL**

parameter	conditions/description	min	typ	max	units
operating temperature	15 & 48 Vdc output models	0		40	°C
	19 Vdc output model	-10		40	°C
	all other output models	-20		40	°C
storage temperature		-20		80	°C
operating humidity	non-condensing	20		80	%
storage humidity	non-condensing	10		90	%

## MECHANICAL

parameter	conditions/description	min	typ	max	units
dimensions	115 x 53 x 38				mm
inlet plug	IEC320/C14				
weight	without ac cord		310		g

## MECHANICAL DRAWING

units: mm  
tolerance: ±1.0 mm

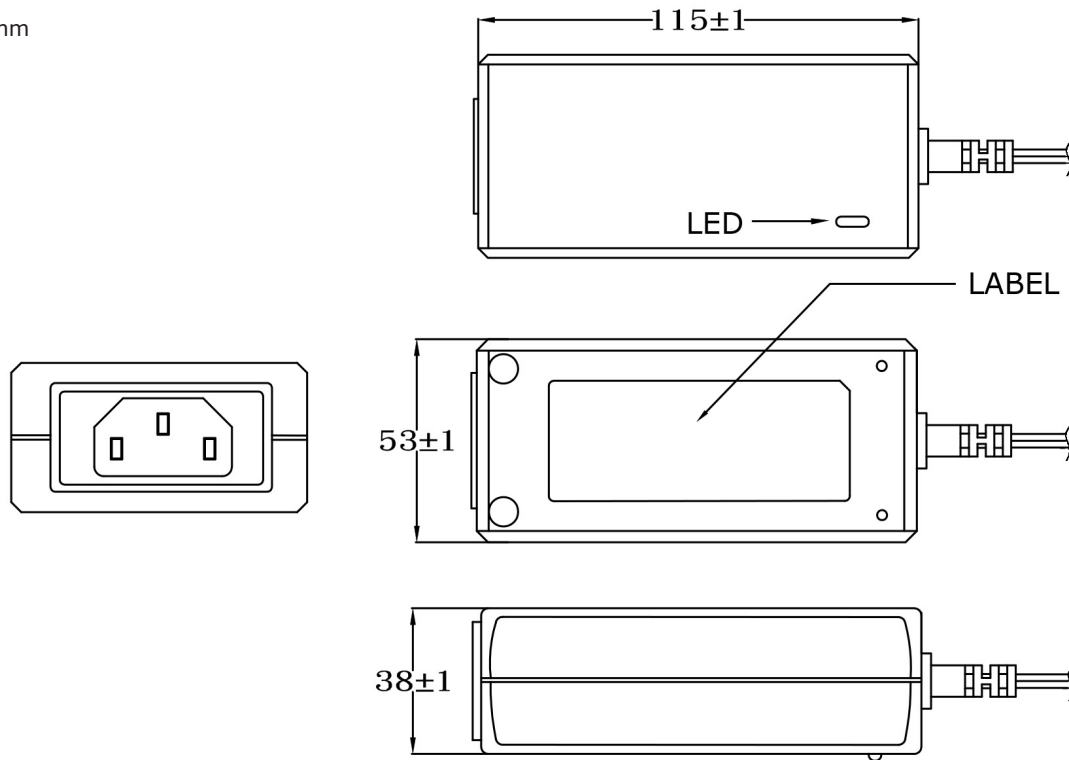

## DC CORD

units: mm

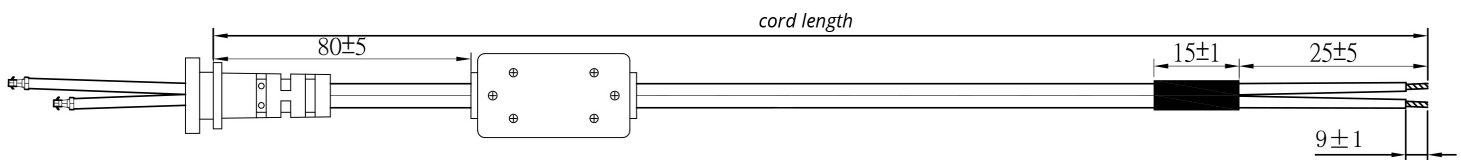
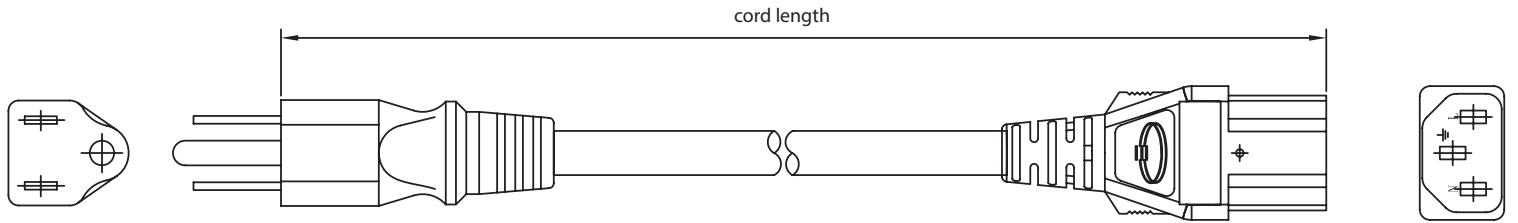

**Table 1**

MODEL NO.	CABLE	CORD LENGTH
SDI65-12-U	UL1185, 16 AWG	1,500 mm ±30
SDI65-15-U	UL1185, 16 AWG	1,500 mm ±30
SDI65-18-U	UL2468, 18 AWG	1,500 mm ±30
SDI65-19-U	UL2468, 18 AWG	1,500 mm ±30
SDI65-24-U	UL2468, 18 AWG	1,500 mm ±30
SDI65-48-U	UL2468, 20 AWG	1,500 mm ±30
SDI65-56-U	UL2468, 22 AWG	1,500 mm ±30

## AC CORD

units: mm



### NORTH AMERICA

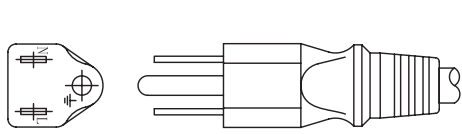

### EUROPE

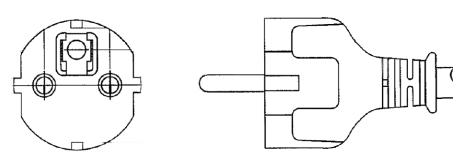

### UNITED KINGDOM

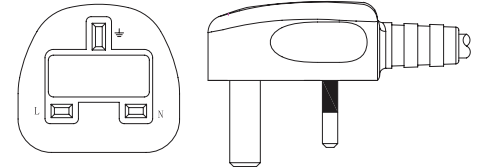

### AUSTRALIA

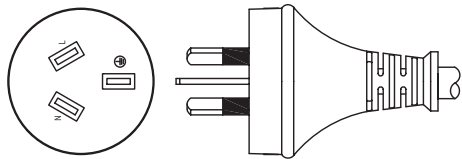

### CHINA

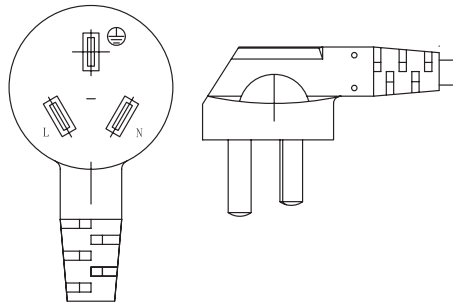

### SOUTH KOREA

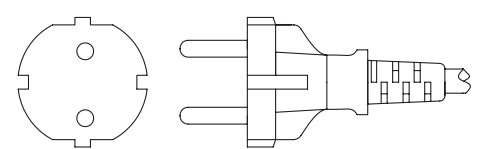

### BRAZIL

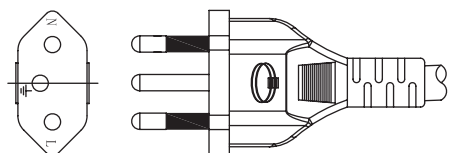

### SOUTH AFRICA

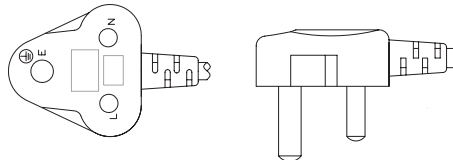

### JAPAN

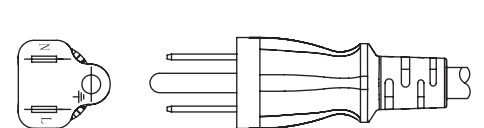

**Table 2**

AC INPUT	CORD LENGTH
North America	1,830 mm ±30
Europe	1,830 mm ±30
United Kingdom	1,830 mm ±30
Australia	1,830 mm ±30
China	1,830 mm ±30
South Korea	1,830 mm ±50
Brazil	1,830 mm ±30
South Africa	1,830 mm ±50
Japan	1,830 mm ±30

## DC PLUG TYPE PART NUMBER KEY

**XXX**

**Plug Polarity:**  
P = Center Positive  
N = Center Negative

**Plug Code:**  
X = Choose a code from the options below

**Plug Angle:**  
"blank" = Straight  
R = Right Angle

Plug Polarity		Code		Dimensions (mm)			Plug Angle	
Center Pos.	Center Neg.	Option	Type	A	B	C	Straight	Right
•	•	5	Standard	5.5	2.1	9.5	•	•
•	•	6	Standard	5.5	2.5	9.5	•	•
•	•	7	Standard	3.5	1.35	9.5	•	•
•	•	8	Standard	3.8	1.35	9.5	•	•
•	•	9	Standard	3.8	1.05	9.5	•	•
•	•	10	Locking <sup>2</sup>	5.5	2.1	9.5	•	N/A
•	•	11	Locking <sup>2</sup>	5.5	2.5	9.5	•	N/A
•	•	12	EIAJ-1	2.35	0.7	9.5	•	•
•	•	13	EIAJ-2	4.0	1.7	9.5	•	•
•	•	14	EIAJ-3	4.75	1.7	9.5	•	•
N/A	N/A	ST	Stripped & Tinned			N/A	N/A	N/A

Note: 1. Contact CUI for additional plug options  
2. Maximum insertion depth is 10mm

### Standard

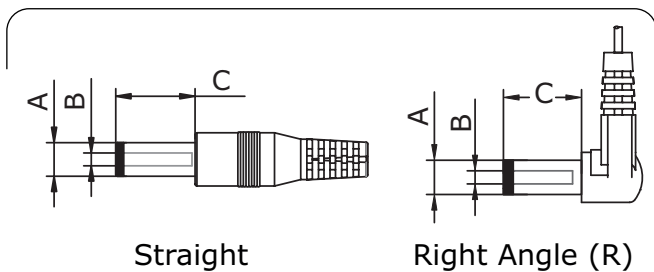

### EIAJ

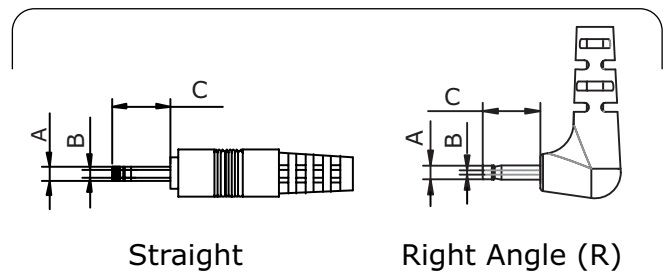

### Locking

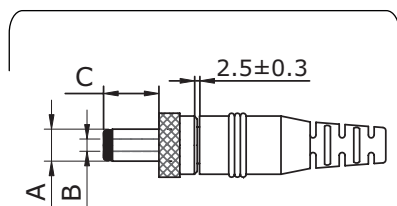

### Stripped & Tinned

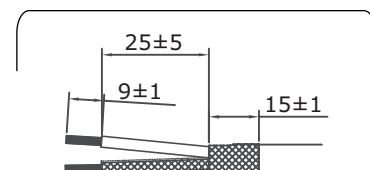

## REVISION HISTORY

rev.	description	date
1.0	initial release	05/13/2015
1.01	updated datasheet	09/15/2016
1.02	added 62368-1 standard	08/31/2018
1.03	removed GS	12/20/2019
1.04	company logo updated	07/23/2020
1.05	UKCA added to specification	08/11/2021
1.06	plug polarity symbols updated	09/16/2021
1.07	mechanical drawing updated	04/13/2022
1.08	dc plugs updated	05/23/2022
1.09	56 Vdc output model added	03/13/2023
1.10	stripped and tinned dimensions updated	06/23/2023

The revision history provided is for informational purposes only and is believed to be accurate.



**Headquarters**  
20050 SW 112th Ave.  
Tualatin, OR 97062  
**800.275.4899**

Fax 503.612.2383  
**cui.com**  
techsupport@cui.com

This device complies with part 15 of the FCC Rules. Operation is subject to the following two conditions:

- (1) This device may not cause harmful interference, and
- (2) this device must accept any interference received, including interference that may cause undesired operation.

CUI offers a one (1) year limited warranty. Complete warranty information is listed on our website.

CUI reserves the right to make changes to the product at any time without notice. Information provided by CUI is believed to be accurate and reliable. However, no responsibility is assumed by CUI for its use, nor for any infringements of patents or other rights of third parties which may result from its use.

CUI products are not authorized or warranted for use as critical components in equipment that requires an extremely high level of reliability. A critical component is any component of a life support device or system whose failure to perform can be reasonably expected to cause the failure of the life support device or system, or to affect its safety or effectiveness.