

KEB SERIES

THREE PHASE GENERAL PURPOSE EMI FILTER

SINGLE STAGE DELTA CONFIGURATION

INTRODUCTION

Three phase General Purpose Filters designed to be used in wide range of applications.

APPLICATION

- Industrial Automation
- HVAC
- Rectifier

FEATURES

- General Purpose
- Standard Attenuation Performance
- Chassis Mounting, Din Rail Mount

APPROVALS AND COMPLIANCE

- UL Recognised
- CSA Certified

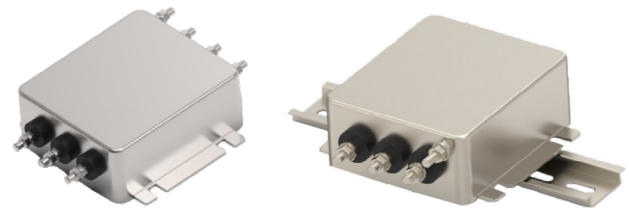

STANDARD

NEW DIN RAIL

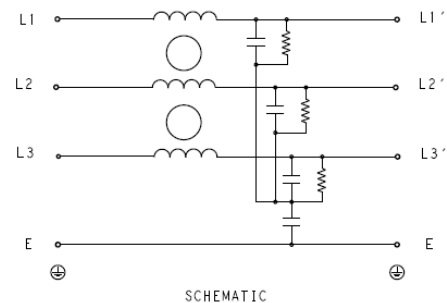

Specifications

Electrical Characteristics	
Maximum Continuous Operating Voltage	440/520VAC
Current Ratings	1A to 150A @40°C, Din Mount 1A to 60A @40°C
Operating Frequency	50/60Hz
High Potential Test Voltage -440VAC	Line to Ground 2632VDC for 1 Minute
	Line to Line 1892VDC for 1 Minute
High Potential Test Voltage -520VAC	Line to Ground 2856VDC for 1 Minute
	Line to Line 2236VDC for 1 Minute
Overload Capability	135% of Rated current for 15 minutes

KEB Series



Three Phase General Purpose EMI Filter

Functional Characteristics	
Operating Temperature Range	-25°C to +85°C
Climatic Category	25/85/21
Termination (Depends on Current Rating)	Quick Connect (1-10A)/Bolt & Nut (15-150A)/Shock Proof (75-100A)
Flammability Corresponding to	UL 94 V-0

Reference Standards	
Design Corresponding to	UL 60939-3 and CSA 22.2 No.8-13

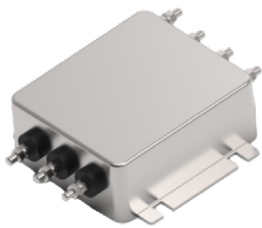

Selection Table - Standard Version



TE Ordering Number	Catalog Number	Rated Current @40°C	Rated Voltage @40°C	Leakage Current (mA)	Weight (Kgs)	Termination		
								
1-1609965-0	1KEBS1AFPD	1A	440 VAC	3	0.26	6.3 x 0.8		
1-1609965-1	3KEBS1AFPD	3A	440 VAC	3	0.26	6.3 x 0.8		
1-1609965-2	6KEBS1AFPD	6A	440 VAC	3	0.26	6.3 x 0.8		
1-1609965-3	10KEBS1AFPD	10A	440 VAC	3	0.26	6.3 x 0.8		
1-1609965-4	15KEBS6AFPD	15A	440 VAC	3	0.7		M5	
1-1609965-5	20KEBS6AFPD	20A	440 VAC	3	0.7		M5	
1-1609965-6	25KEBS6AFPD	25A	440 VAC	5	0.7		M5	
1-1609965-7	30KEBS6AFPD	30A	440 VAC	5	0.7		M5	
1-1609965-8	40KEBS6AFPD	40A	440 VAC	5	0.7		M5	
1-1609965-9	50KEBS6AFPD	50A	440 VAC	5	1.2		M6	
2-1609965-0	60KEBS6AFPD	60A	440 VAC	5	1.2		M6	
2-1609965-1	75KEBS6AFPD	75A	440 VAC	6	8		M8	
2-1609965-2	80KEBS6AFPD	80A	440 VAC	6	8		M8	
2-1609965-3	100KEBS6AFPD	100A	440 VAC	6	8		M10	
2-1609965-4	125KEBS6AFPD	125A	440 VAC	8	8		M10	
2-1609965-5	150KEBS6AFPD	150A	440 VAC	8	8		M10	
2-1609965-6	75KEBS10AFPD	75A	440 VAC	6	8			16
2-1609965-7	80KEBS10AFPD	80A	440 VAC	6	8			25
2-1609965-8	100KEBS10AFPD	100A	440 VAC	6	8			25
4-1609965-0	1KEBS1BFPD	1A	520 VAC	3	0.26	6.3 x 0.8		

KEB Series

Three Phase General Purpose EMI Filter

TE Ordering Number	Catalog Number	Rated Current @40°C	Rated Voltage @40°C	Leakage Current (mA)	Weight (Kgs)	Termination		
								
4-1609965-1	3KEBS1BFPD	3A	520 VAC	3	0.26	6.3 x 0.8		
4-1609965-2	6KEBS1BFPD	6A	520 VAC	3	0.26	6.3 x 0.8		
4-1609965-3	10KEBS1BFPD	10A	520 VAC	3	0.26	6.3 x 0.8		
4-1609965-4	15KEBS6BFPD	15A	520 VAC	3	0.7		M5	
4-1609965-5	20KEBS6BFPD	20A	520 VAC	3	0.7		M5	
4-1609965-6	25KEBS6BFPD	25A	520 VAC	5	0.7		M5	
4-1609965-7	30KEBS6BFPD	30A	520 VAC	5	0.7		M5	
4-1609965-8	40KEBS6BFPD	40A	520 VAC	5	0.7		M5	
4-1609965-9	50KEBS6BFPD	50A	520 VAC	5	1.2		M6	
5-1609965-0	60KEBS6BFPD	60A	520 VAC	5	1.2		M6	
5-1609965-1	75KEBS6BFPD	75A	520 VAC	6	8		M8	
5-1609965-2	80KEBS6BFPD	80A	520 VAC	6	8		M8	
5-1609965-3	100KEBS6BFPD	100A	520 VAC	6	8		M10	
5-1609965-4	125KEBS6BFPD	125A	520 VAC	8	8		M10	
5-1609965-5	150KEBS6BFPD	150A	520 VAC	8	8		M10	
5-1609965-6	75KEBS10BFPD	75A	520 VAC	6	8			16
5-1609965-7	80KEBS10BFPD	80A	520 VAC	6	8			25
5-1609965-8	100KEBS10BFPD	100A	520 VAC	6	8			25

Selection Table - Din Rail Mount



NEW

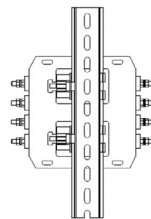

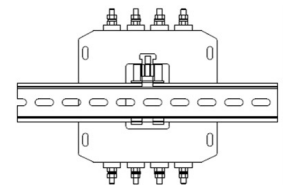

VERTICAL MOUNT

Note: Din Rail not supplied





HORIZONTAL MOUNT

TE Ordering Number	Catalog Number	Din Type	Rated Current @40°C	Rated Voltage @40°C	Leakage Current (mA)	Weight (Kgs)	Termination	
								
3-1609965-0	1KEBS1AFPDDM	DUAL	1A	440 VAC	3	0.36	6.3 x 0.8	
3-1609965-1	3KEBS1AFPDDM	DUAL	3A	440 VAC	3	0.36	6.3 x 0.8	
3-1609965-2	6KEBS1AFPDDM	DUAL	6A	440 VAC	3	0.36	6.3 x 0.8	
3-1609965-3	10KEBS1AFPDDM	DUAL	10A	440 VAC	3	0.36	6.3 x 0.8	
3-1609965-4	15KEBS6AFPDDM	DUAL	15A	440 VAC	3	0.8		M5
3-1609965-5	20KEBS6AFPDDM	DUAL	20A	440 VAC	3	0.8		M5

KEB Series

Three Phase General Purpose EMI Filter

TE Ordering Number	Catalog Number	Din Type	Rated Current @40°C	Rated Voltage @40°C	Leakage Current (mA)	Weight (Kgs)	Termination	
								
3-1609965-6	25KEBS6AFPDDM	DUAL	25A	440 VAC	5	0.8		M5
3-1609965-7	30KEBS6AFPDDM	DUAL	30A	440 VAC	5	0.8		M5
3-1609965-8	40KEBS6AFPDDM	DUAL	40A	440 VAC	5	0.8		M5
3-1609965-9	50KEBS6AFPDHM	HORIZONTAL	50A	440 VAC	5	1.3		M6
6-1609965-0	60KEBS6AFPDHM	HORIZONTAL	60A	440 VAC	5	1.3		M6
6-1609965-1	50KEBS6AFPDVM	VERTICAL	50A	440 VAC	5	1.4		M6
6-1609965-2	60KEBS6AFPDVM	VERTICAL	60A	440 VAC	5	1.4		M6
6-1609965-3	1KEBS1BFPDDM	DUAL	1A	520 VAC	3	0.36	6.3 x 0.8	
6-1609965-4	3KEBS1BFPDDM	DUAL	3A	520 VAC	3	0.36	6.3 x 0.8	
6-1609965-5	6KEBS1BFPDDM	DUAL	6A	520 VAC	3	0.36	6.3 x 0.8	
6-1609965-6	10KEBS1BFPDDM	DUAL	10A	520 VAC	3	0.36	6.3 x 0.8	
6-1609965-7	15KEBS6BFPDDM	DUAL	15A	520 VAC	3	0.8		M5
6-1609965-8	20KEBS6BFPDDM	DUAL	20A	520 VAC	3	0.8		M5
6-1609965-9	25KEBS6BFPDDM	DUAL	25A	520 VAC	5	0.8		M5
7-1609965-0	30KEBS6BFPDDM	DUAL	30A	520 VAC	5	0.8		M5
7-1609965-1	40KEBS6BFPDDM	DUAL	40A	520 VAC	5	0.8		M5
7-1609965-2	50KEBS6BFPDHM	HORIZONTAL	50A	520 VAC	5	1.3		M6
7-1609965-3	60KEBS6BFPDHM	HORIZONTAL	60A	520 VAC	5	1.3		M6
7-1609965-4	50KEBS6BFPDVM	VERTICAL	50A	520 VAC	5	1.4		M6
7-1609965-5	60KEBS6BFPDVM	VERTICAL	60A	520 VAC	5	1.4		M6

Connectors Cross Section

	4	10	16	25	50
Wire Section (mm ²)	4mm ²	10 mm ²	16 mm ²	25 mm ²	50 mm ²
Wire Section (AWG)	12AWG	8 AWG	6 AWG	4 AWG	1/0 AWG
Wire Stripping	max 10mm	max 13.5 mm	max 17 mm	max 17 mm	max 20 mm
Max Recommended Torque	0.5 Nm/4.5 in.lbs	1.2 Nm/10.8 in.lbs	2-2.2 Nm/ 18-19.8 in.lbs	2 Nm/18 in.lbs	6 Nm/54 in.lbs

KEB Series

Three Phase General Purpose EMI Filter

Insertion Loss (Typical) – Measured in Closed 50Ω System

		Common Mode 50Ω/50Ω								
		Frequency in MHz								
		0.01	0.05	0.15	0.5	1	3	5	10	30
Current Rating	1A	2	3	4	11	20	40	35	35	45
	3A	2	2	19	22	40	38	45	47	34
	6A	3	5	13	19	33	40	42	48	31
	10A	3	4	15	25	29	30	30	32	31
	15A	4	5	8	20	30	38	48	30	22
	20A	2	2	5	15	22	36	53	39	28
	25A	3	5	5	18	23	35	40	44	24
	30A	2	4	6	18	24	32	35	39	27
	40A	5	5	12	22	34	39	45	37	46
	50A	3	3	10	23	32	34	45	43	30
	60A	2	4	5	22	27	30	32	35	24
	75A	2	3	4	11	20	40	35	35	45
	80A	4	5	8	15	18	22	35	42	45
	100A	2	4	3	17	23	25	25	32	38
	125A	2	2	5	12	18	25	32	40	45
150A	2	3	6	15	22	28	30	35	42	

		Differential Mode 50Ω/50Ω								
		Frequency in MHz								
		0.01	0.05	0.15	0.5	1	3	5	10	30
Current Rating	1A	3	4	6	17	27	33	36	38	54
	3A	4	5	36	38	29	35	38	46	45
	6A	4	4	15	25	30	38	45	54	56
	10A	4	5	20	29	30	31	32	35	40
	15A	7	7	10	17	28	40	42	38	49
	20A	3	6	6	14	20	44	32	25	23
	25A	4	4	19	22	26	32	48	50	52
	30A	4	8	15	22	35	42	40	48	50
	40A	7	7	11	23	31	38	44	41	51
	50A	3	4	8	29	31	36	42	49	49
	60A	2	5	5	24	42	38	40	31	29
	75A	3	4	6	17	27	33	36	38	54
	80A	4	4	10	20	24	30	36	40	42
	100A	7	8	14	43	37	40	35	30	40
	125A	3	3	9	14	19	31	35	42	42
150A	2	2	8	20	25	31	35	40	47	

KEB Series

Three Phase General Purpose EMI Filter

Common Mode Insertion Loss (Typical in dB - Refer to table above)

1A

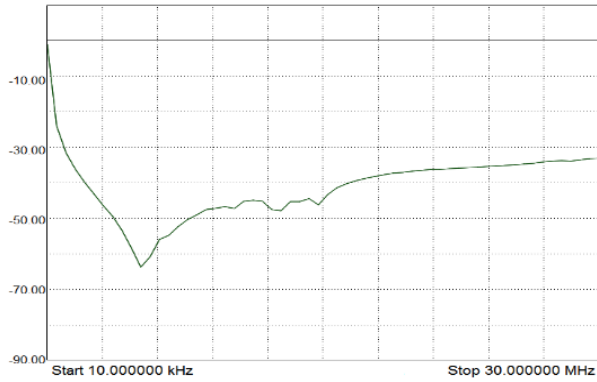

3A

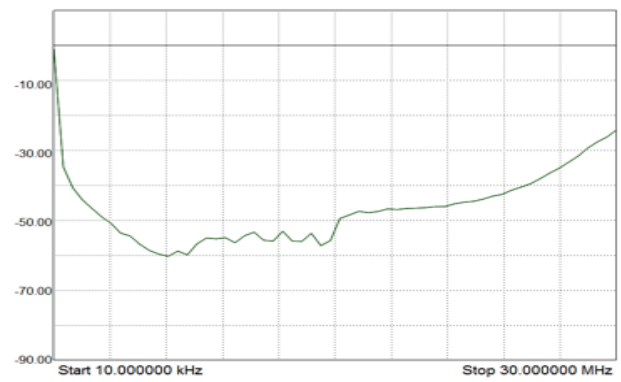

6A

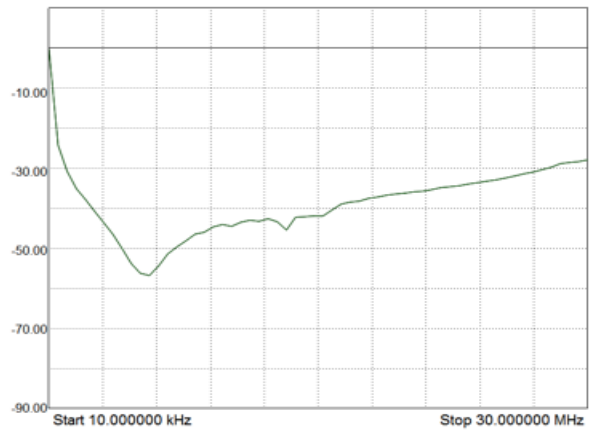

10A

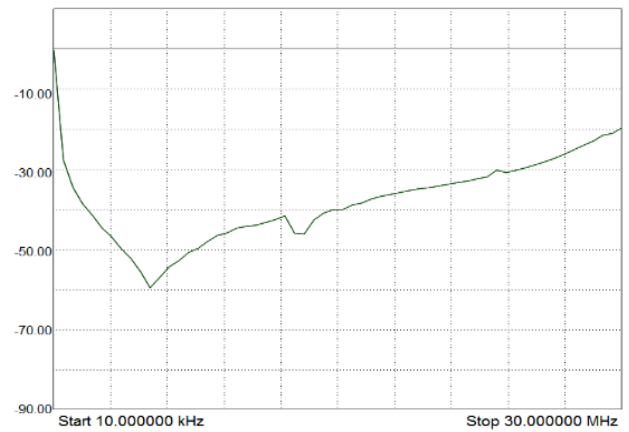

15A

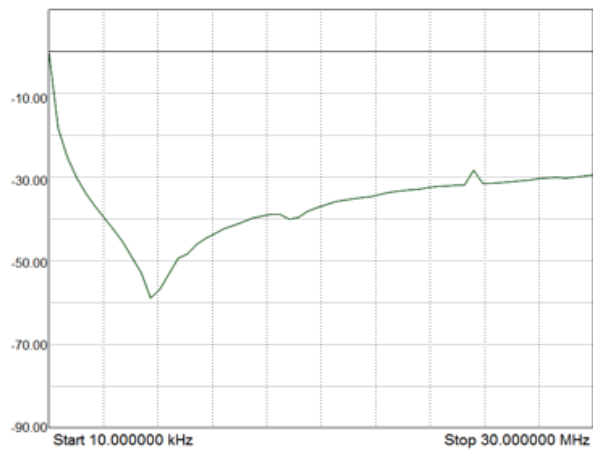

20A

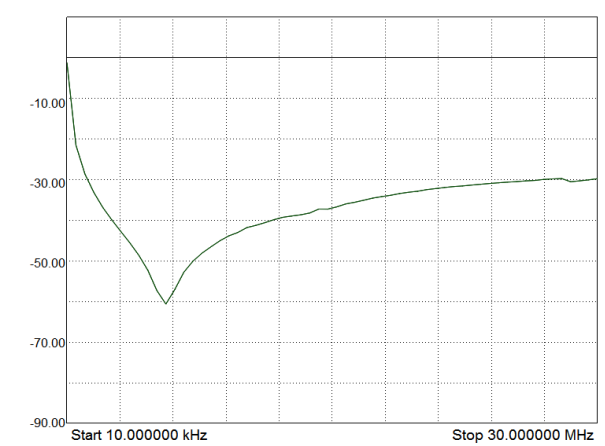

KEB Series

Three Phase General Purpose EMI Filter

Common Mode Insertion Loss (Typical in dB - Refer to table above)

25A

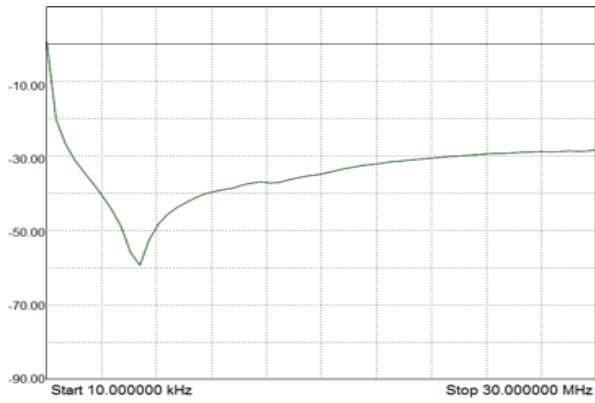

30A

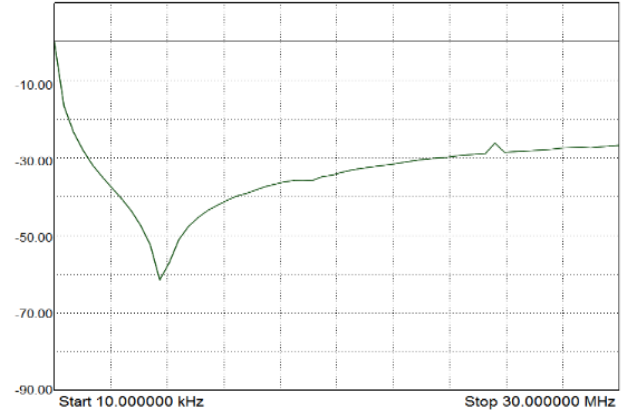

40A

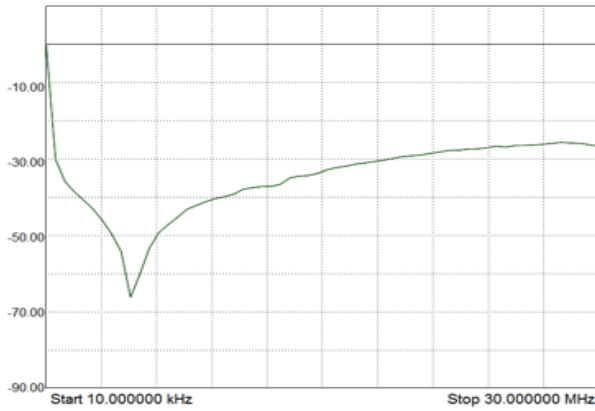

50A

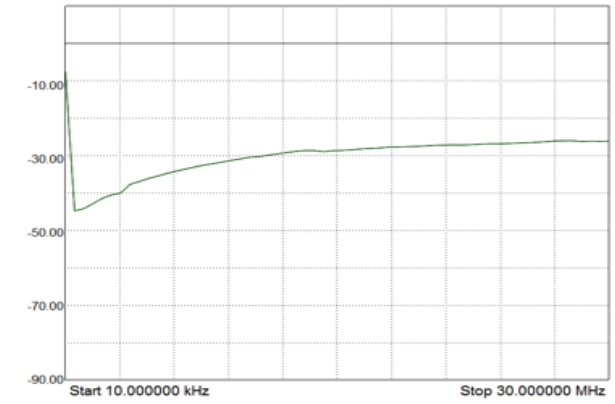

60A

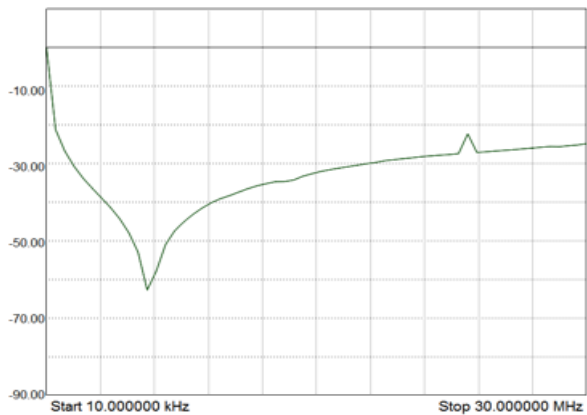

75A

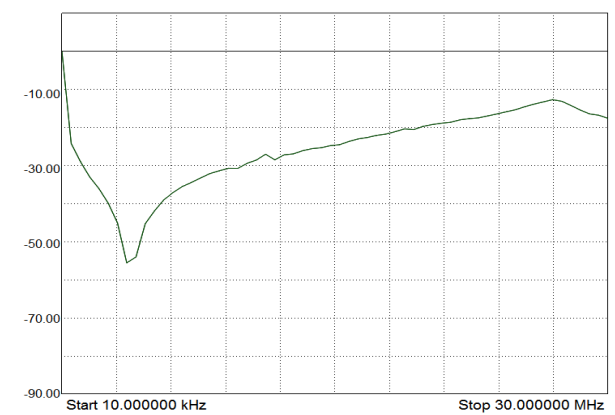

KEB Series

Three Phase General Purpose EMI Filter

Common Mode Insertion Loss (Typical in dB - Refer to table above)

80A

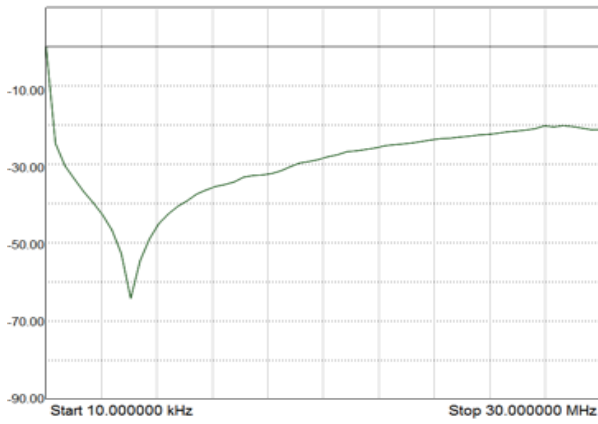

100A

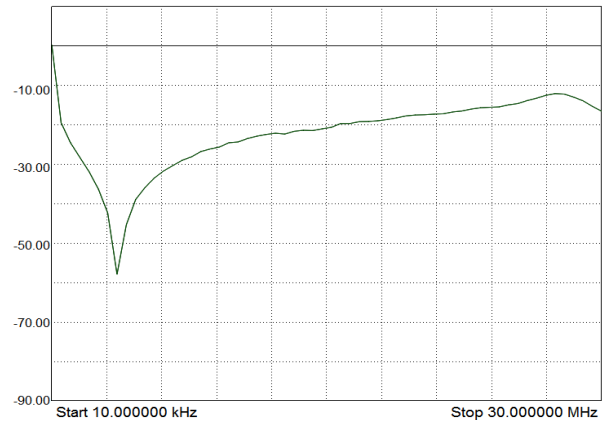

125A

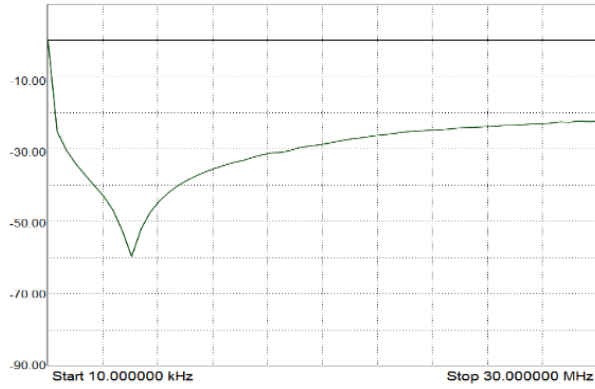

150A

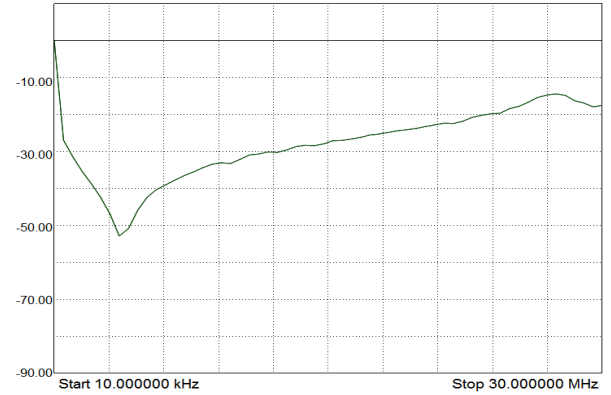

KEB Series

Three Phase General Purpose EMI Filter

Case Dimensions - Standard Version

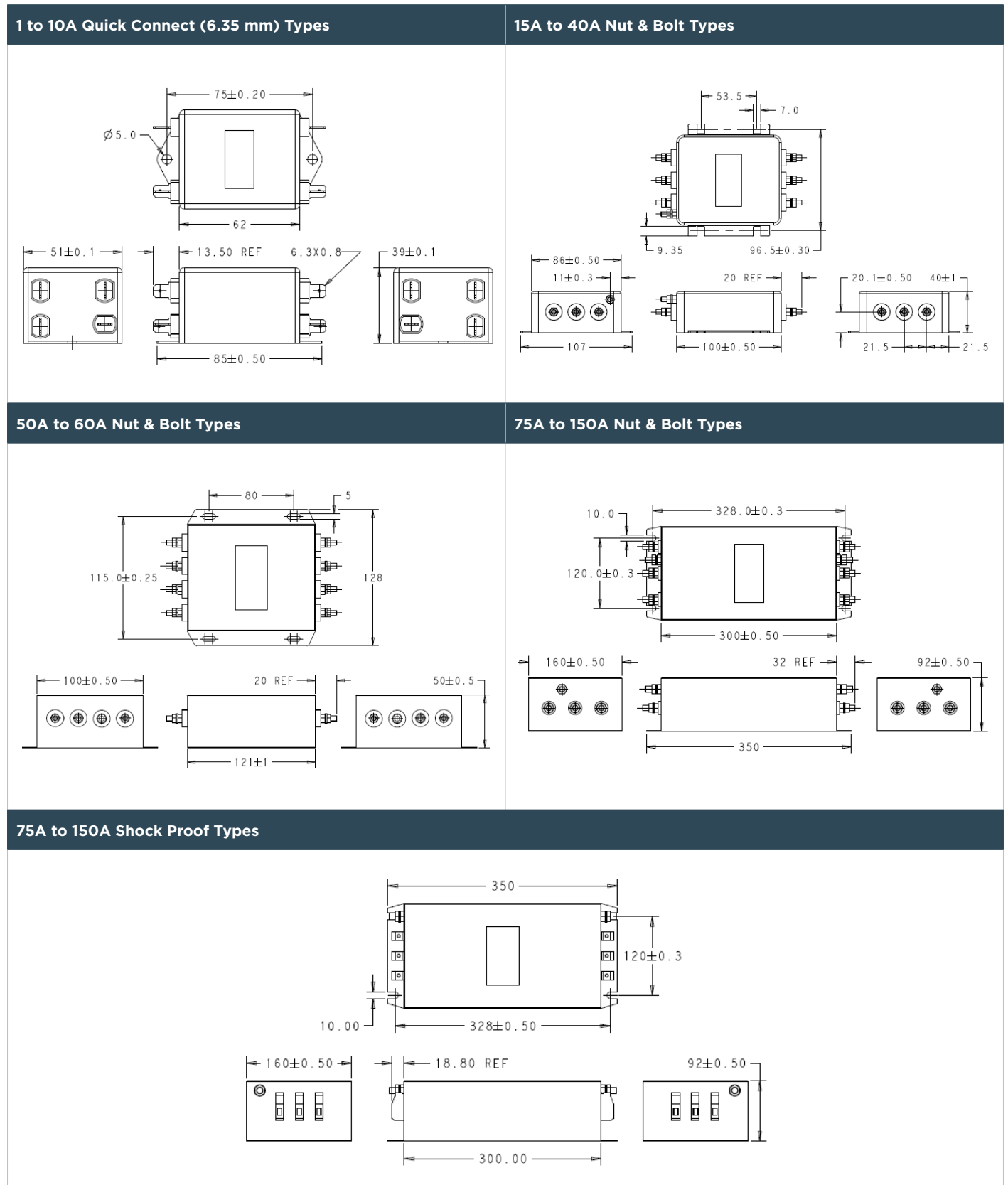

All dimensions in mm; Tolerances according: ISO2768-m

KEB Series

Three Phase General Purpose EMI Filter

Case Dimensions - Din Rail Mount

1 to 10A Quick Connect (6.35mm) Types - Dual Mount

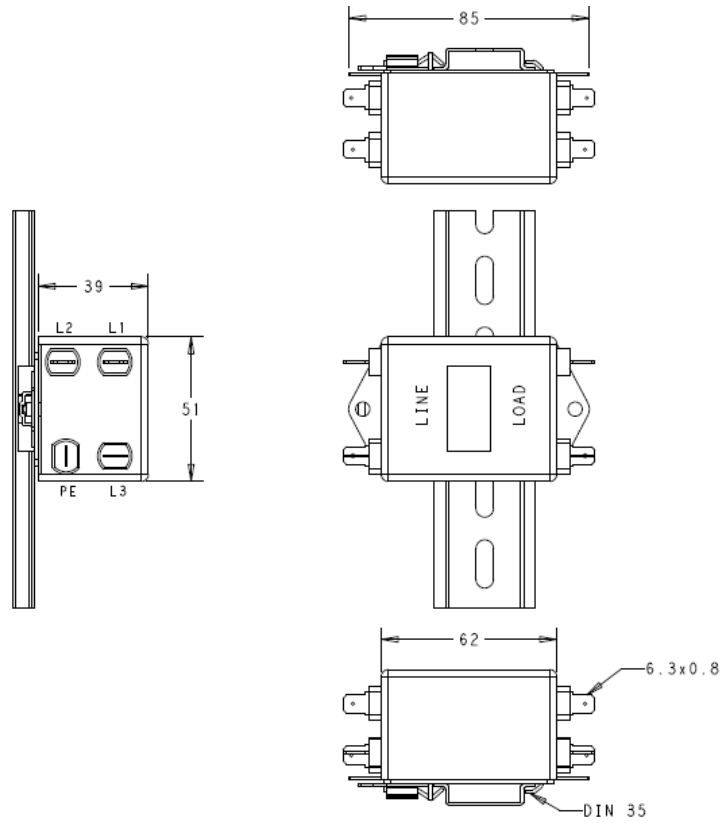

15A to 40A Nut & Bolt Types - Dual Mount

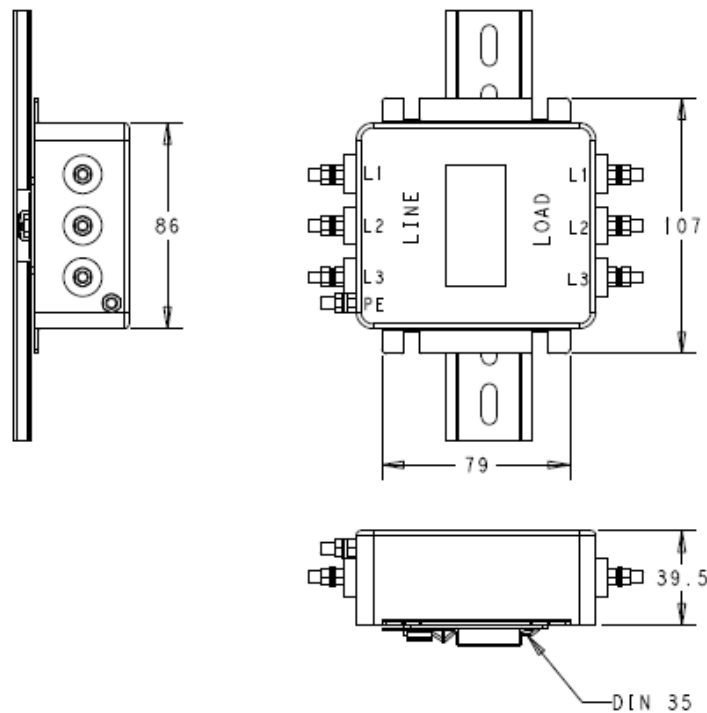

KEB Series

Three Phase General Purpose EMI Filter

Case Dimensions - Din Rail Mount

50A to 60A Nut & Bolt Types - Horizontal Mount

Note: Din Rail not supplied

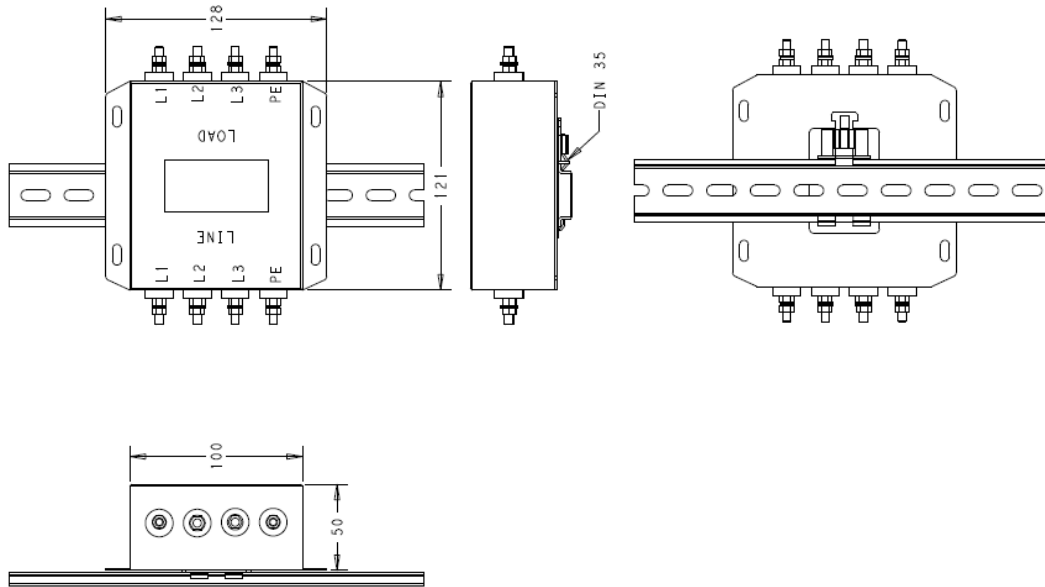

50A to 60A Nut & Bolt Types - Vertical Mount

Note: Din Rail not supplied

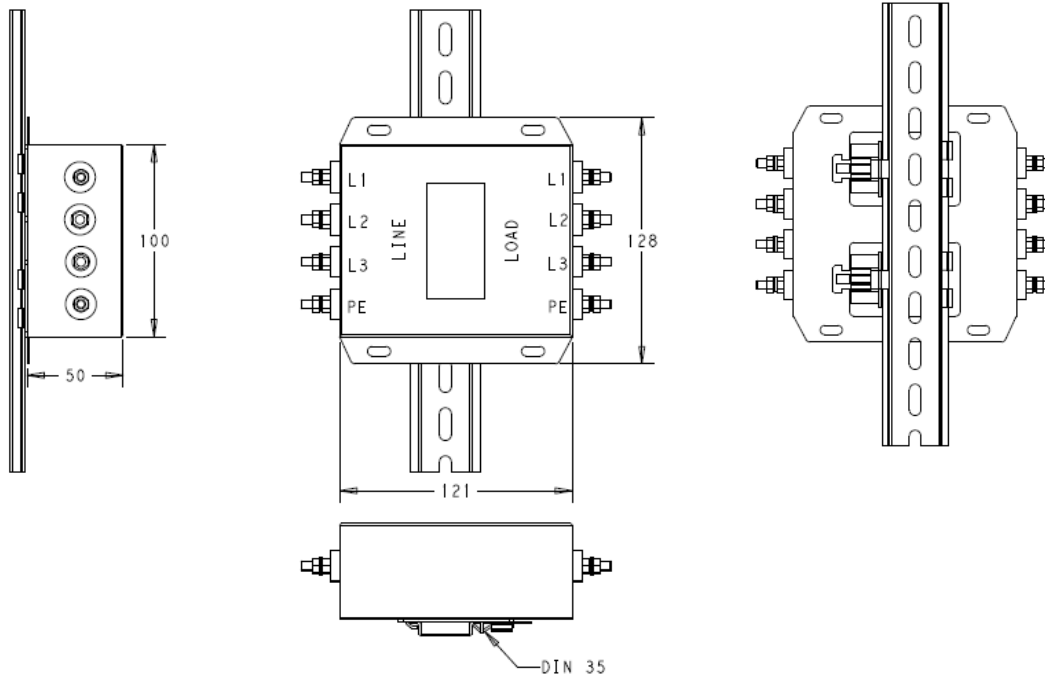

HOW TO ORDER

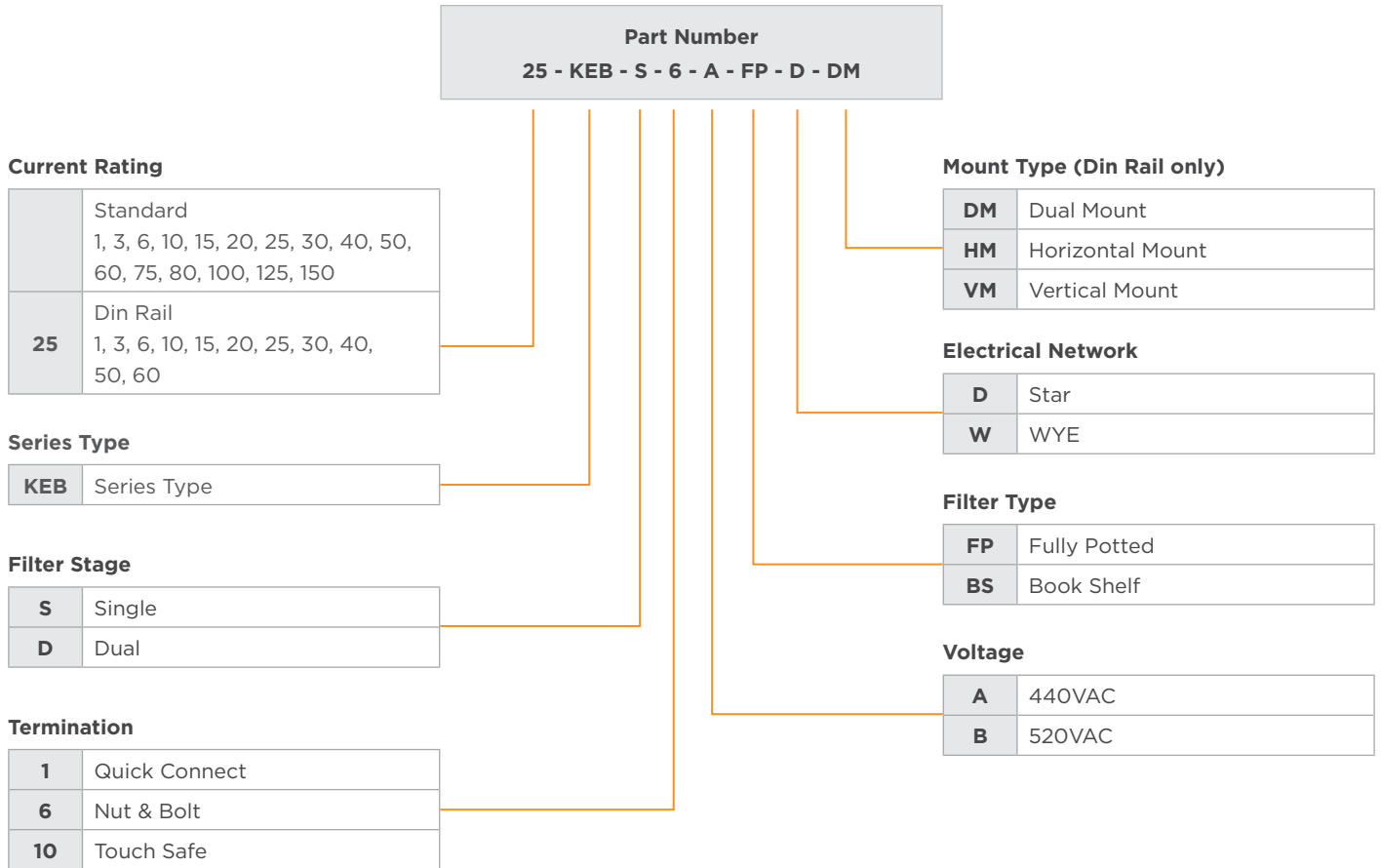

[te.com](https://www.te.com)

©2022 TE Connectivity. All Rights Reserved.

TE Connectivity, TE Connectivity (logo) and Every Connection Counts are trademarks. All other logos, products and/or company names referred to herein might be trademarks of their respective owners.

The information given herein, including drawings, illustrations and schematics which are intended for illustration purposes only, is believed to be reliable. However, TE Connectivity makes no warranties as to its accuracy or completeness and disclaims any liability in connection with its use. TE Connectivity's obligations shall only be as set forth in TE Connectivity's Standard Terms and Conditions of Sale for this product and in no case will TE Connectivity be liable for any incidental, indirect or consequential damages arising out of the sale, resale, use or misuse of the product. Users of TE Connectivity products should make their own evaluation to determine the suitability of each such product for the specific application.

12/22 ED