

1452993-1 x OBSOLETE

MCON Interconnection System

TE Internal #: 1452993-1

TE Internal Description: 36 POS COVER ASSY

[View on TE.com >](#)



Automotive Parts > Automotive Connector Accessories > Automotive Connector Caps & Covers



Number of Positions: **36**

Primary Product Color: **Black**

Protection & Strain Relief Accessory Type: **Cover Assembly**

Primary Product Material: **PBT GF**

Strain Relief: **With**

Features

Product Type Features

Protection & Strain Relief Accessory Type	Cover Assembly
---	----------------

Configuration Features

Number of Positions	36
---------------------	----

Body Features

Primary Product Color	Black
Primary Product Material	PBT GF

Mechanical Attachment

Strain Relief	With
---------------	------

Packaging Features

Packaging Method	Box
Packaging Quantity	135

Other

Serviceable	No
-------------	----



Product Compliance

[For compliance documentation, visit the product page on TE.com>](#)

EU RoHS Directive 2011/65/EU	Compliant
EU ELV Directive 2000/53/EC	Compliant
China RoHS 2 Directive MIIT Order No 32, 2016	No Restricted Materials Above Threshold
EU REACH Regulation (EC) No. 1907/2006	Current ECHA Candidate List: JAN 2025 (247) Candidate List Declared Against: JUNE 2024 (241) Does not contain REACH SVHC
Halogen Content	BFR/CFR/PVC Free, but Br/Cl >900 ppm in other sources.
Solder Process Capability	Not applicable for solder process capability

Product Compliance Disclaimer

This information is provided based on reasonable inquiry of our suppliers and represents our current actual knowledge based on the information they provided. This information is subject to change. The part numbers that TE has identified as EU RoHS compliant have a maximum concentration of 0.1% by weight in homogenous materials for lead, hexavalent chromium, mercury, PBB, PBDE, DBP, BBP, DEHP, DIBP, and 0.01% for cadmium, or qualify for an exemption to these limits as defined in the Annexes of Directive 2011/65/EU (RoHS2). Finished electrical and electronic equipment products will be CE marked as required by Directive 2011/65/EU. Components may not be CE marked. Additionally, the part numbers that TE has identified as EU ELV compliant have a maximum concentration of 0.1% by weight in homogenous materials for lead, hexavalent chromium, and mercury, and 0.01% for cadmium, or qualify for an exemption to these limits as defined in the Annexes of Directive 2000/53/EC (ELV). Regarding the REACH Regulation, the information TE provides on SVHC in articles for this part number is based on the latest European Chemicals Agency (ECHA) 'Guidance on requirements for substances in articles' posted at this URL: <https://echa.europa.eu/guidance-documents/guidance-on-reach>

Also in the Series | MCON Interconnection System

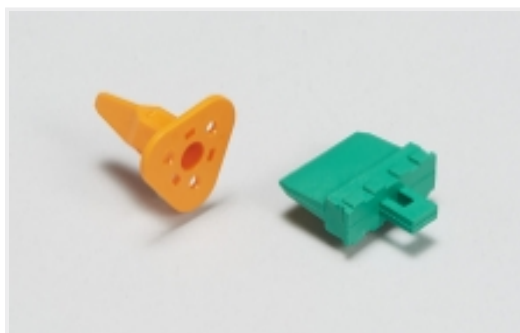

Automotive Connector Locks & Position Assurance(14)



Automotive Housings(112)



Automotive Seals & Cavity Plugs(12)



Automotive Signal & Power Connector Housings(112)

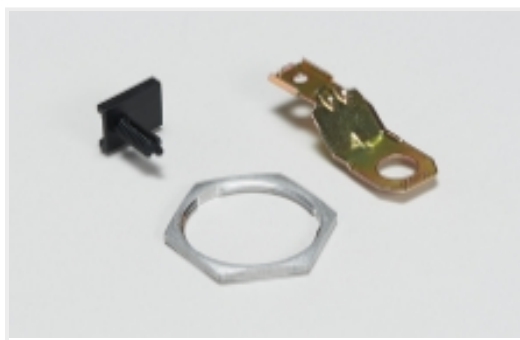

Other Automotive Connector Accessories(1)

Customers Also Bought



TE Part #284715-1
32 POS AIRBAG CONN SHELL WITH

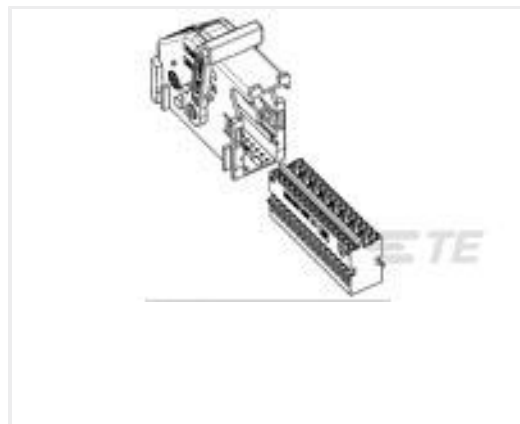

TE Part #284999-6
32 POS. KIT ASSY FOR AIRBAG
VERSION FOR



TE Part #2236269-3
24POS, MIXED, REC HSG,
20GENYMCP, ASSY, CODC



TE Part #7-2209637-7
AKII CABLE ASSY



TE Part #2300271-9
SAIC ZS11 AKII CABLE ASSY

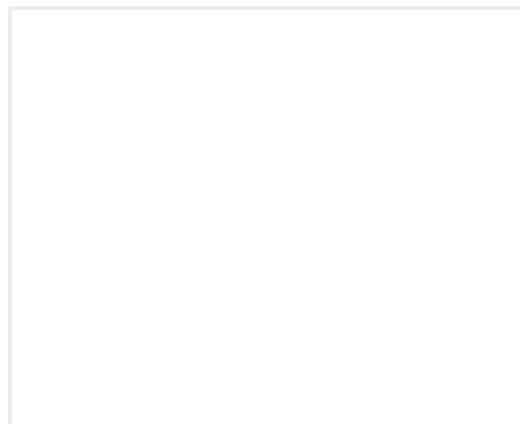

TE Part #2324934-1
14POS, GB/T DC, CHARGE INLET
ASSY, AND AC,

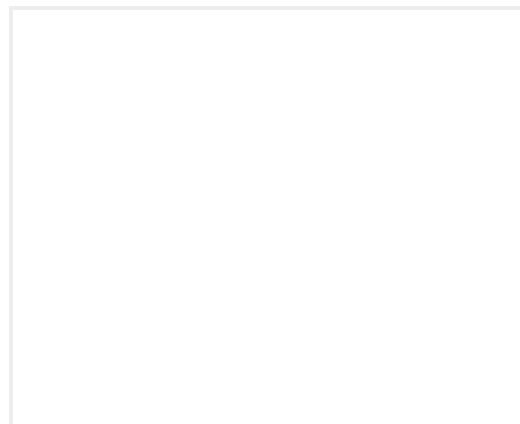

TE Part #2349802-1
T1E 1.5T BOX ASSY

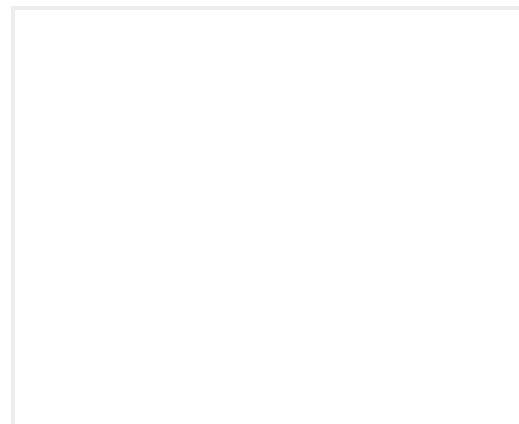

TE Part #2349802-2
T1E 1.6T BOX ASSY

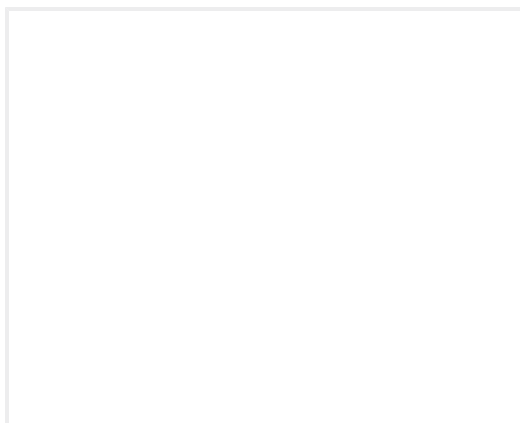

TE Part #1-2375320-1
XB19 BELT HEATER, AUTO SHUT OFF

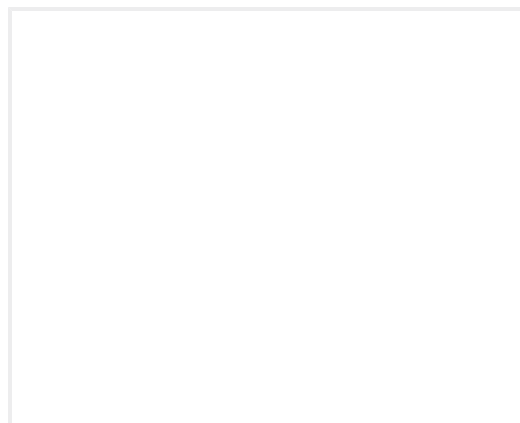

TE Part #2344903-1
MATENET CABLE ASSY

Documents

Product Drawings
36 POS COVER ASSY

English

CAD Files

3D PDF

3D

Customer View Model

ENG_CVM_CVM_1452993-1_B.2d_dxf.zip



English

Customer View Model

[ENG_CVM_CVM_1452993-1_B.3d_igs.zip](#)

English

Customer View Model

[ENG_CVM_CVM_1452993-1_B.3d_stp.zip](#)

English

By downloading the CAD file I accept and agree to the [Terms and Conditions](#) of use.

Product Specifications

[Application Specification](#)

English