

RAIL D-SUB BACKSHELLS

FOR D-SUBMINIATURE CONNECTORS

RAIL D-SUB BACKSHELLS

FOR D-SUBMINIATURE CONNECTORS

A comprehensive range of ruggedized metal backshells for D-Subminiature connectors. Fast easy installation and assembly thanks to a practical construction with a minimum number of single parts. TE Connectivity (TE) have many options available including two cable exit variants and a unique retrofitable quick-lock system for easy robust assembly in tight spaces. With a cable exit option of crimp inserts ensuring unparalleled 360° EMI/EMC Shielding, the crimp insert also protects the conductors against damage during the crimping process. For quick and easy installation we also have a screw strain relief cable exit option which required no special tooling.

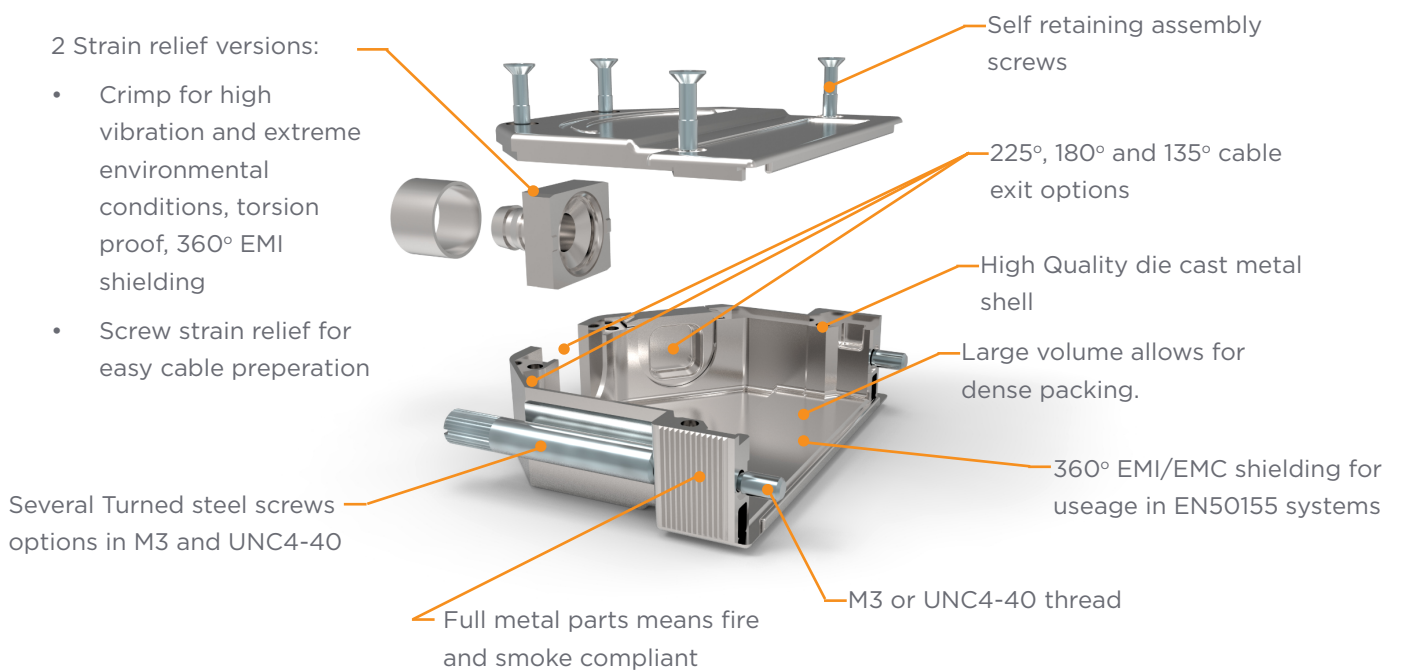

Cable Outlet	Size 1 9/15p	Size 2 15/26p	Size 3 25/44p	Size 4 37/62p	Size 5 50/78p
180° Cable Outlet					
135° Cable Outlet					
225° Cable Outlet					

D-Sub Backshells

For D-Subminiature Connectors

Screw Lock Options

With multiple screw lock options our D-Sub backshells meet all requirements for D-Subminiature connectors.

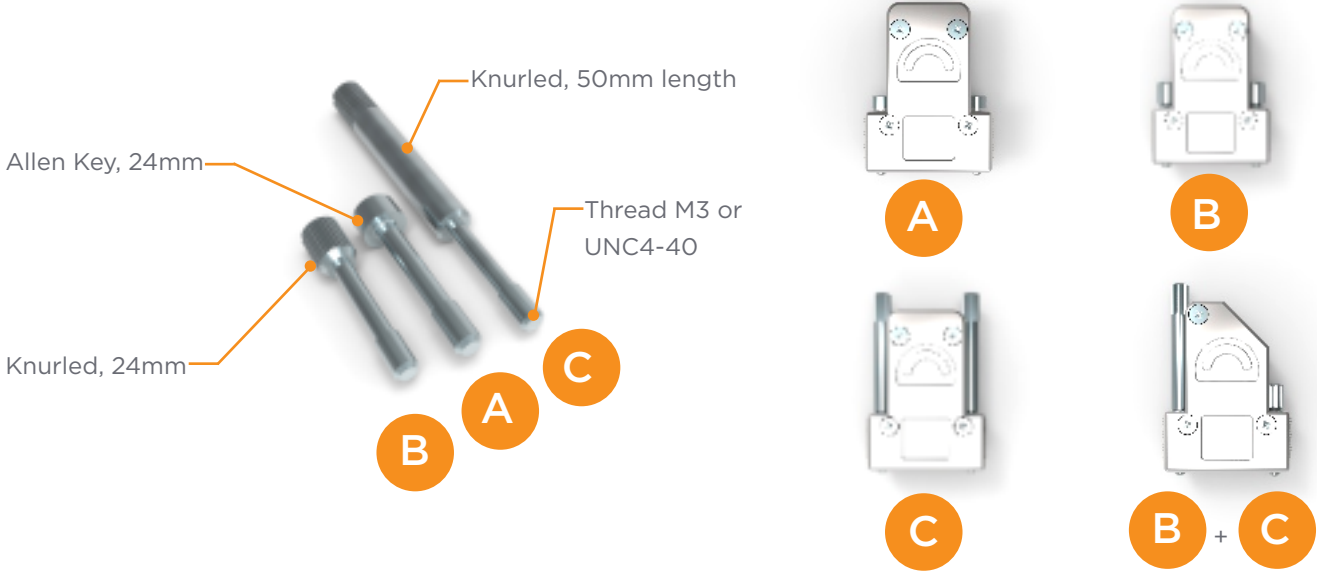

Ordering Information

	Positions	Picture	Thread	Screw Length				Cable Outlet		
				Locking screw w/ spring washer	Locking Screw short knurled	Locking screw Long knurled	Locking screw long knurled and locking screw short knurled	180°	135°	225°
1	9P/15P		UNC 4-40	1-2308340-1	1-2308340-3	1-2308340-5	-	●		
			M3	1-2308340-2	1-2308340-4	1-2308340-6	-	●		
			UNC-4-40	1-2308340-7	1-2308340-9	-	2-2308340-1		●	
			M3	12308340-8	2-230834-0	-	2-2308340-2		●	
2	15/26P		UNC 4-40	1-2308341-1	1-2308341-3	1-2308341-5	-	●		
			M3	1-2308341-2	1-2308341-4	1-2308341-6	-	●		
			UNC 4-40	1-2308341-7	1-2308341-9	-	2-2308341-1		●	
			M3	1-2308341-8	2-2308341-0	-	2-2308341-2		●	
3	25/44P		UNC 4-40	1-2308342-1	1-2308342-3	1-2308342-5	1-2308342-7	●	●	
			M3	1-2308342-2	1-2308342-4	1-2308342-6	1-2308342-8	●	●	
4	37/62P		UNC 4-40	1-2308345-1	1-2308345-3	1-2308345-5	1-2308345-7	●	●	●
			M3	1-2308345-2	1-2308345-4	1-2308345-6	1-2308345-8	●	●	●
5	50/78P		UNC 4-40	1-2308346-1	1-2308346-3	1-2308346-5	1-2308346-7	●	●	●
			M3	1-2308346-2	1-2308346-4	1-2308346-6	1-2308346-8	●	●	●

D-Sub Backshells

For D-Subminiature Connectors

Quick Lock Hoods

Our quick lock versions are an effective, time saving solution, with self retaining assembly screws and with its 'squeeze to release' self locking system it also provides three cable exit options in just one single part.

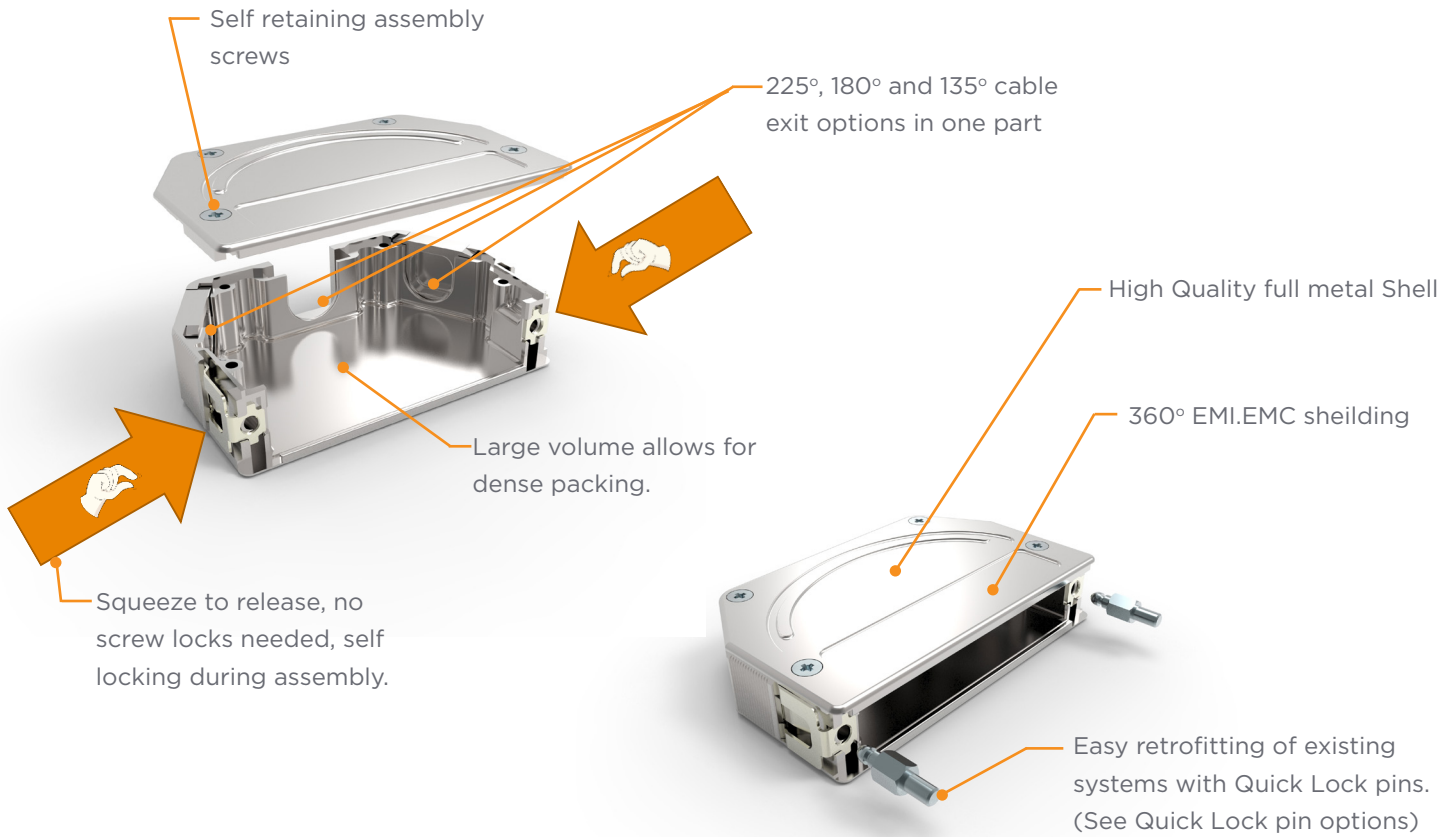

Quick Lock pin options

<p>A Fixed female screwlock</p> <p>D-Sub Female connector</p> <p>Quick lock pins mounted in existing M3 or UNC4-40 sockets</p> <p>Panel (front or back mounted)</p>	<p>C Standard mounting hole</p> <p>Length depending on panel thickness</p> <p>Quick lock pins mounted in standard mounting holes using M3 nuts</p> <p>Panel (front mounted)</p>
<p>B Threaded insert</p> <p>Length depending on panel thickness</p> <p>Quick lock pins mounted in threaded sockets on the backside of the connector</p> <p>Panel (front mounted)</p>	<p>D Bracket mounting (2x Sub-D)</p> <p>2x D-Sub connector used to connect two cables with each other</p> <p>Quick lock pins mounted in bracket using locking ring</p> <p>Panel</p>

D-Sub Backshells

For D-Subminiature Connectors

Ordering Information

Quick Lock Versions

Quick Lock Shells						
Shell Size	Positions	Picture	Part Number	Cable Outlet		
				225°	180°	135°
1	9p/15p		1-2308319-1	●	●	●
2	15p/26p		1-2308321-1	●	●	●
3	25p/44p		1-2308327-1	●	●	●
4	37p/62p		1-2308330-1	●	●	●
5	50p/78p		1-2308338-1	●	●	●

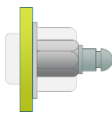
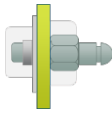
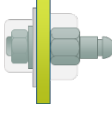
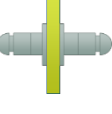
Quick Lock Pin Options				
	Picture	PN	Thread	Panel Thickness
A		1-2308273-1	M3	N/A
		1-2308273-2	4-40 UNC	N/A
B		1-2308265-1	4-40 UNC	N/A
		1-2308265-2	4-40 UNC	1.0-1.3
		1-2308265-3	4-40 UNC	1.5-1.8
		1-2308265-4	4-40 UNC	1.7-2.0
		1-2308265-5	4-40 UNC	2.2-2.5
		1-2308265-6	M3	N/A
		1-2308265-7	M3	1.0-1.3
		1-2308265-8	M3	1.5-1.8
		1-2308265-9	M3	1.7-2.0
		2-2308265-0	M3	2.2-2.5
C		1-2308290-1	M3	1.7-2.0
D		1-2308298-1	N/A	1.25
		1-2308298-2		1.5
		1-2308298-3		2
		1-2308298-4		2.2
		1-2308298-5		2.5
		1-2308298-6		3

D-Sub Backshells

For D-Subminiature Connectors

Cable Exit options

Option 1: Crimped Strain relief

Cable rotation can lead to breakage of the individual wires in the cable. This can lead to intermittent system errors which are typically very difficult to find.

The Solution: Crimping the cable jacket

Advantage: A well defined and proven method. The crimp insert protects the conductors against damage during the crimping process.

Creating Unparalleled EMI Shielding all around the connector.

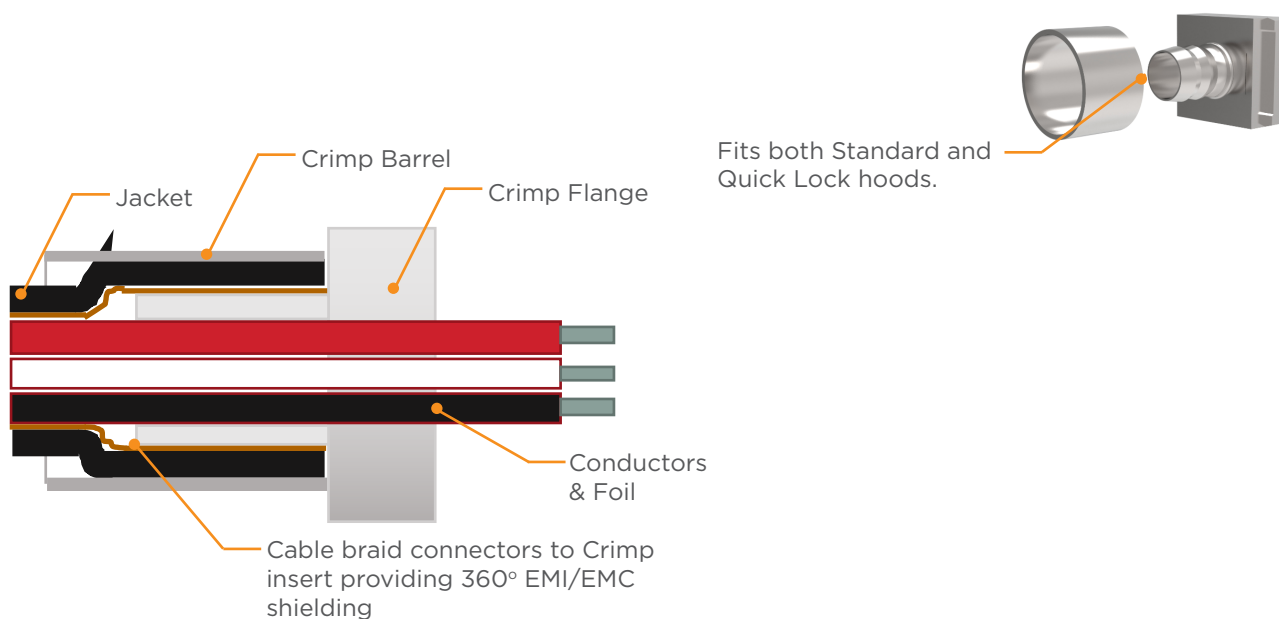

How to select the correct crimp flange

Step	Description	Example
1	Measure the outside cable diameter (3 times on different places at different angles)	OD = 6.5mm
2	Strip the cable and remove the cable braiding	
3	Measure the diameter of the inner cable bundle including the foil	ID = 4.4mm
4	Select the crimp flange with a hole diameter next up to the cable bundle diameter	PN = 2-2308349-1, ID = 4.5mm, OD = 5.5mm
5	Calculate the recommended barrel inner diameter with the following formula: Recommended Inner crimp barrel diameter = OD of crimp flange + 2x(thickness of the cable jacket) + 0.2mm	Thickness cable jacket = $(6.5 - 4.4) / 2 = 1.05\text{mm}$ Barrel ID = $5.5\text{mm} + 2 \times 1.05 + 0.2\text{mm} = 7.8\text{mm}$
6	Select the crimp barrel with the next size up	PN = 1-2308350-7, ID = 8.0mm, OD = 9.0mm
7	Order the correct crimp tool & crimp insert using the crimp barrel selection matrix	PN = 1-2823557-1 & 1-2823558-3
8	Prepare a cable sample and check if the pull out force meets your requirements. Contact TE Connectivity representative in case of any questions.	

D-Sub Backshells

For D-Subminiature Connectors

Ordering Information

Crimp Strain relief

Crimp flanges (Can be used with all shells)

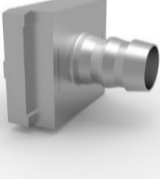
Picture	Size 1-4 QD shells 1-3 Std Shells P/N	Size 5 QD shells or size 4-5 Std Shells P/N	Inner diameter / cable diameter	Outer diameter
	2-2308349-4	1-2308348-1	3.0	4.0
	2-2308349-3	1-2308348-2	3.5	4.5
	2-2308349-2	1-2308348-3	4.0	5.0
	2-2308349-1	1-2308348-4	4.5	5.5
	2-2308349-0	1-2308348-5	5.0	6.0
	1-2308349-9	1-2308348-6	5.5	6.5
	1-2308349-8	-	5.7	6.7
	1-2308349-7	1-2308348-7	6.0	7.0
	1-2308349-6	1-2308348-8	6.5	7.5
	1-2308349-5	1-2308348-9	7.0	8.0
	1-2308349-4	1-2308348-0	7.6	8.5
	1-2308349-3	2-2308348-1	8.0	9.0
	1-2308349-2	2-2308348-2	8.5	9.5
	1-2308349-1	2-2308348-3	9.0	10.0
	-	2-2308348-4	9.5	10.5
	-	2-2308348-5	10.0	11.0
	-	2-2308348-6	10.5	11.5
-	2-2308348-7	11.0	12.0	

Recommended Tooling



TE

Cable Jacket stripping tool
2119000-1

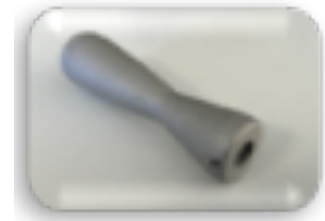

Crimp flange insert tool
1-2314418-1 for small size
flanges
1-2314418-2 for large
size flanges

Crimp barrel (in combination wth crimp flanges)

Picture	Part Number	Barrel Inner diame- ter/cable diameter	Barrel Outer diameter	PN recommended crimp insert
	1-2308350-1	5.0	6.0	1-2823558-8
	1-2308350-2	5.5	6.5	1-2823558-9
	1-2308350-3	6.0	7.0	2-2823558-0
	1-2308350-4	6.5	7.5	2-2823558-1
	1-2308350-5	7.0	8.0	2-2823558-2
	1-2308350-6	7.5	8.5	2-2823558-3
	1-2308350-7	8.0	9.0	2-2823558-4
	1-2308350-8	8.5	9.5	2-2823558-5
	1-2308350-9	9.0	10.0	2-2823558-6
	2-2308350-0	9.5	10.5	2-2823558-7
	2-2308350-1	10.0	11.0	2-2823558-8
	2-2308350-2	10.5	11.5	2-2823558-9
	2-2308350-3	11.0	12.0	3-2823558-0
	2-2308350-4	11.5	12.5	3-2823558-1
	2-2308350-5	11.7	13.0	3-2823558-2
	2-2308350-6	12.0	13.0	3-2823558-3
	2-2308350-7	12.5	13.5	3-2823558-4
	2-2308350-8	13.0	14.0	3-2823558-5
	2-2308350-9	13.7	15.0	3-2823558-6
	3-2308350-0	14.0	15.0	3-2823558-7
3-2308350-1	14.5	15.5	3-2823558-8	
3-2308350-2	16.0	17.0	3-2823558-9	



Crimp tool
1-2823557-1



Crimp Insert
X-2823558-X (see table for
recommended crimp insert)

D-Sub Backshells

For D-Subminiature Connectors

Cable Exit Options

Option 2: Cable outlet with screws

For quick and easy installation requiring no special tools our cable outlet with screws option suits those needing a fast and simple installation. With a two piece cable clamp to allow for effective strain relief this cable exit is fitted with ribs to prevent cable retention.

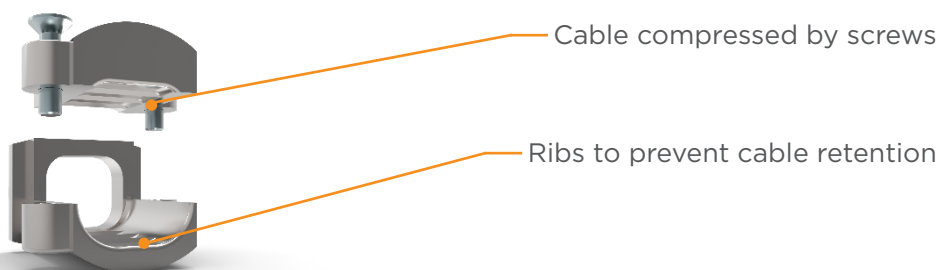
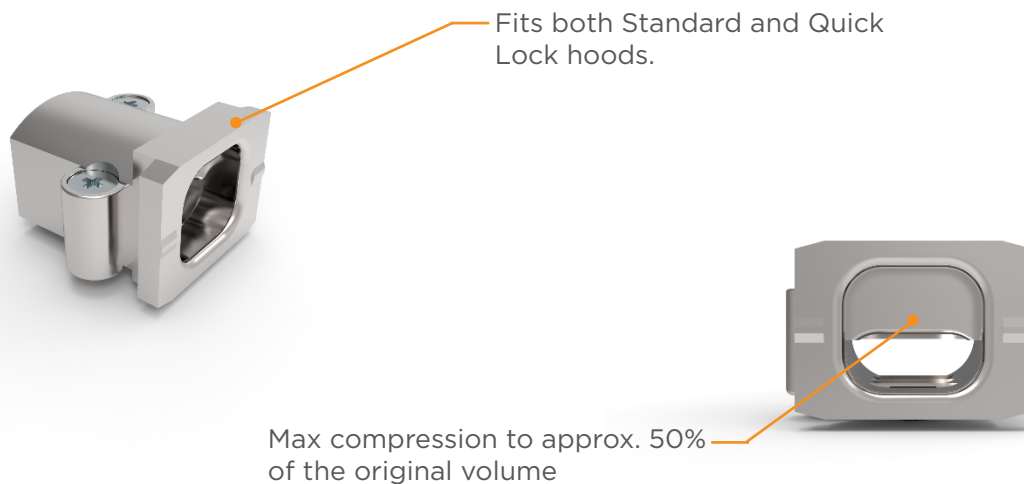

Ordering Information

Fits on shells		Cable diameter	Part Number
Standard shell	Quick Lock shell		
Size 1-3 (small)	Size 1-4	4-7mm	1-2308272-1
		7-10mm	1-2308272-2
		9-12mm	1-2308272-3
		11-14mm	1-2308272-4
Size 4-5 (Large)	Size 5	8-10mm	1-2308272-5
		11-14mm	1-2308272-6
		14-16mm	1-2308272-7

LET'S CONNECT

We make it easy to connect with our experts and are ready to provide all the support you need. Just call your local support number or visit www.te.com/industrial to chat with a Product Information Specialist.

TECHNICAL SUPPORT

te.com/support-center

Australia	+86 400-820-6015	France	+33 1-34-20-8686	Korea	+02-3415-4607
Austria	+43 1-9056-0	Germany	+49 6151-607-1999	Latvia	+37 2-6778-673
Belgium	+31 73-6246999	Greece	+97 1-4-347-0226	Lithuania	+37 037426900
Brazil	+55 11-2103-6000	Holland	+31 73-6246999	Luxembourg	+31 73-6246999
China	+86 400-820-6015	Hungary	+36 1-2892040	Netherlands	+31 73-6246999
Czech Republic	+42 02-7201-1103	India	+86 400-820-6015	New Zealand	+86 400-820-6015
Denmark	+46 8-5072-5000	Ireland	+1 800-882-391	Norway	+46 8-5072-5000
Estonia	+37 2677-8673	Italy	+39 011-4012111	Poland	+48 22-4576750
Finland	+46 8-5072-5000	Japan	+044-844-8052	Portugal	+34 91-6630420

te.com

TE Connectivity, TE Connectivity (logo), Every Connection Counts are trademarks. All other logos, products and/or company names referred to herein might be trademarks of their respective owners.

The information given herein, including drawings, illustrations and schematics which are intended for illustration purposes only, is believed to be reliable. However, TE Connectivity makes no warranties as to its accuracy or completeness and disclaims any liability in connection with its use. TE Connectivity's obligations shall only be as set forth in TE Connectivity's Standard Terms and Conditions of Sale for this product and in no case will TE Connectivity be liable for any incidental, indirect or consequential damages arising out of the sale, resale, use or misuse of the product. Users of TE Connectivity products should make their own evaluation to determine the suitability of each such product for the specific application.

© 2016 TE Connectivity Ltd. family of companies All Rights Reserved.

1-1773876-6 CC 0317

TE Connectivity
Data Solutions